

# Railways

## Electrical safety equipment

Edition 2009



*Railway division*





# Golden Rules

**1** First, select the right equipment



**2** SEPARATE THE WORK AREA FROM ALL POSSIBLE SOURCES OF POWER-SUPPLY  
by opening circuit-breakers, switches...  
and lock the links in the open position



**3** CHECK THE ABSENCE OF VOLTAGE  
at source and on site, on each conductor and apparatus involved

**4** APPLY APPROPRIATE SHORT-CIRCUIT AND EARTHING SYSTEMS  
in sufficient numbers on the conductors  
of your network  
where operation is taking place



**5** SHOWN, WARN OTHERS AND LIMIT THE WORK AREA  
even during the most simple temporary maintenance operation



# Summary

PRODUCTS AND REFERENCES INDEX 4

EQUIPMENT FOR INTERVENTION ON CATENARIES 7

EQUIPMENT FOR INTERVENTION  
ON ELECTRICAL URBAN TRANSPORTS 21

EQUIPMENT FOR LINES,  
SUBSTATIONS AND INSTALLATIONS 29

PERSONAL PROTECTIVE EQUIPMENT 49

PADLOCKS AND WARNING SIGNS 55

GENERAL TOOLS 59



# References Index

References	Page(s)	References	Page(s)	References	Page(s)
AL-200	56	CC-245-225/420	41	CM-4125-*	15/43
AL-201/1	56	CC-245-225/550-K	41	CM-4130-*	15/43
AL-201-C/1	56	CC-245-63/150-K	41	CM-4220*	15/43
AL-202	56	CC-245-63/90	41	CM-4230*	15/43
AL-230-111-EX	56	CC-245-66/132-K	41	CM-4240*	15/43
AL-230-S-222-EX	56	CC-245-90/225-K	41	CM-4330*	15/43
AL-236-111-EX	56	CC-248-110-K	41	CM-4345*	15/43
AL-236-222-EX	56	CC-45-K	34	CM-4360*	15/43
AL-236-S-111-EX	56	CC-575-10/20-BS	34	CM-4600-J	15/43
AL-236-S-222-EX	56	CC-575-10/30-BS	34	CM-4610	15/43
AL-240-111-EX	56	CC-575-5/15-BS	34	CM-4610-*	15/43
AL-240-S-222-EX	56	CC-577-10/17.5	34	CM-4610-I	15/43
AL-31/25	10/30/58	CC-578-15	11/34	CM-4615	15/43
AL-316	10/30/58	CC-875-5,5/20	35	CM-4615-*	15/43
AL-318	10/30/58	CC-875-10/36*	35	CM-4615-I	15/43
AL-32/05	10/30/58	CC-875-11/33*	35	CM-4620	15/43
AL-58	10/30/58	CC-875-25	12/35	CM-4620-*	15/43
AL-60	10/30/58	CD-104	31	CM-4620-I	15/43
AL-62-A	10/30/58	CD-122	31	CM-4625	15/43
AL-63-A	10/30/58	CD-124	31	CM-4625-*	15/43
AM-20-GB	10/58	CD-130	65	CM-4625-I	15/43
AM-20-RM	10/58	CD-140	65	CM-6-15	44
AM-344-GB	10/58	CD-302	31	CM-6-20	44
AM-345-GB	10/58	CE-306	31	CM-6-25	44
AM-41/1	10/58	CE-4-21*	48	CM-6-30	44
AM-49/1	10/58	CE-5-40*	48	CM-7-10-A	48
AM-61-GB	10/58	CE-5-50-C	16	CS-225*	53
AT-41/025	57	CE-5-50-K	16	CS-45*	30/53
AT-41/05	57	CE-5-90-C	63	CS-90*	53
AT-41/1	57	CG-02	51	CT-7-25/1	30/53
AT-49/025	57	CG-05	51	CT-7-40/1	53
AT-49/05	57	CG-10	51	CT-7-63	53
AT-49/1	57	CG-117	52	CT-9-25	53
AT-50/025	57	CG-12	51	CT-9-45	53
AT-50/053	57	CG-15	51	CT-9-63	53
AT-50/1	57	CG-20	51	CZ-53-R	65
AT-51/025	57	CG-30	51	CZ-54-MR	31
AT-51/05	57	CG-30-C	30	CZ-54-R	31
AT-51/1	57	CG-35/1	30/52	CZ-55-MR	31
AT-52/05	57	CG-36	52	CZ-55-R	31
AT-52/1	57	CG-40	51	ENR-1510	66
AT-53/05	57	CG-80	52	ENR-1516	66
AT-53/1	57	CG-96	52	ENR-1525	66
AT-54/05	57	CG-98	52	ENR-1535	66
AT-54/1	57	CI-06-D	30/48	ENR-2510	66
AT-55/05	57	CI-10-D	48	ENR-2516	66
AT-55/1	57	CI-12-D	48	ENR-2525	66
AT-56/05	57	CI-23	30	ENR-2535	66
AT-56/1	57	CL-1607/1	28	ENR-4006	66
AT-57/05	57	CL-1607-ML	28	KIT-ARC-01	60
AT-57/1	57	CL-4-41/2	34	KIT-ARC-02	60
AT-58/05	57	CL-5-03	37	KIT-ARC-03	60
AT-58/1	57	CL-5-33-GB	37	KIT-ARC-04	60
AT-59/1	57	CL-5-36	37	KIT-01*	30
AT-59/05	57	CL6-3000	13	KIT-10**	30
AT-60/05	57	CL-7-06/18	37	KIT-HAUT-01-*	63
AT-60/1	57	CL-7-10/30	37	KIT-HAUT-02-*	63
AT-61/05	57	CL-7-10/30-1	37	KIT-HAUT-03-*	63
AT-61/1	57	CL-7-12/36	37	KIT-HAUT-04-*	63
AT-62/05	57	CM-1-10	16	KIT-HAUT-05-*	63
AT-62/1	57	CM-1-15	16	KIT-HAUT-06-*	63
AT-63/05	57	CM-1-20	16	M-24-120-S	46
AT-63/1	57	CM-3000	15	M-24-150-S	46
AT-66/1	57	CM-3-03	16	M-24-35-S	18
CC-151-K	34	CM-3-04	16	M-24-40-S	18
CC-1515-100	13/37	CM-3-05	16	M-24-50-S	18/46
CC-1515-101	13/37	CM-3-06	16	M-24-70-S	18/46
CC-1515-102	13/37	CM-4115-*	15/43	M-24-95-S	18/46
CC-245-150/420-K	41	CM-4120-*	15/43	M-87-153	44



# References Index

References	Page(s)	References	Page(s)	References	Page(s)
M-87-295	44	MP-42/16*	30/54	MV-135*	54
M-87369	32	MP-42/66	54	ZANTC M8	36
M-87384	50	MP-506/2	64	ZANTCT M8	36
M-87-53	44	MP-508/2	64	ZANTD M8	36
M-881622	50	MP-510/2	64	ZANTP M8	36
M-881635	50	MP-514/2	64	ZANTV M8	36
M-95-864	51	MP-515/2	64	ZAPSP 08	48
M-95-865	51	MP-60/03-10	54	ZCCVZ 25	27
MC-120/15	33	MP-60/03-5	54	ZCCVZC 25	17
MC-120/50	33	MP-60/05-10	54	ZCCVZC 25 1	17
MC-244/1	33	MP-60/05-5	54	ZCCVZC 25 B	17
MC-245/1	33	MP-700-1	60	ZCESS-35/05 MR	26
MD-02	61	MP-700-2	60	ZEMCC 3763 P 300-25	45
MG-115/1-S	48	MP-700-3	60	ZEMCC-3162-BC	18
MO-052	62	MP-700-4	60	ZEMCT 32 SNCF PS	33
MO-11000	50	MS-118	51	ZEMCT 847 SNCF	20
MO-11001	50	MS-122	51	ZEMCT NAC 01	33
MO-11003	50	MS-127	51	ZEMRC 200 B	17
MO-11010	50	MS-911/2	32	ZEMRC 201 B	17
MO-11011	50	MS-911/BR	32	ZEMRC 300 B	17
MO-16-A	64	MS-911-EX	32	ZEMRC 301 B	17
MO-17-A	64	MT-128	18	ZET-3R	28
MO-182/1-B	50	MT-1910	39	ZET-62040	19
MO-182/1-J	50	MT-1911	20/38	ZET-62042	19
MO-182/1-R	50	MT-1911-E	38	ZETMR 35	26
MO-183-BL	50	MT-1911-S1	38	ZETMR 41	26
MO-183-RL	50	MT-1920	39	ZETMR RG 29	26
MO-184	50	MT-1921	20/28/38	ZETMRTO	19
MO-185-BL	50	MT-1921-E	38	ZETMR UNIV	26
MO-186	50	MT-1921-S1	38	ZETRT 35	26
MO-23	64	MT-2951	38	ZPL7R 120N	26
MO-24	64	MT-2951/1	38	ZPL9R 130 FL	45
MO-25	64	MT-2951/2	38	ZPTVZCR 4603 W	25
MO-26	64	MT-300	28	ZPTVZCR 5003	26
MO-35	64	MT-3951	38	ZPTVZCR 5403	16
MO-52020	61	MT-3951/1	38	ZPTVZCR 5603	16/27
MO-52021	61	MT-3952	38	ZPTVZCR 5603 B	16/27
MO-52031	63	MT-3952/1	38	ZRAVZC 200	16
MO-52033	63	MT-5805	39	ZSMT-848/100	19/28
MO-52034	63	MT-731*	42	ZSTA 1-75	47
MO-52-L	61	MT-732*	42	ZSTA 2-116	47
MO-53	62	MT-734*	42	ZSTA 2-116 USI	47
MO-54	62	MT-735*	42	ZSTA 2-147	47
MO-54000	62	MT-737-H	42	ZSTA 2-147 DP	47
MO-54002	62	MT-790	47	ZSTA 2-147 USI	47
MO-54004	62	MT-792	47	ZSTA 2-181	47
MO-54005	63	MT-797	47	ZSTDA 1-75	47
MO-54010	61	MT-812-C	38	ZSTDA 2-116	47
MO-55/1	62	MT-813-C	38	ZSTDA 2-147	47
MO-56009	62	MT-814/2-C	38	ZSTDA 2-147 DP	47
MO-56010	62	MT-814/3-C	38	ZSTDA 2-181	47
MO-563*	61	MT-815-C	38	ZSTDN 147	47
MO-564*	61	MT-815-E	17/38	ZSTDN 181	47
MO-591000	63	MT-815-S	38	ZSTDN 75-116	47
MO-591002	62	MT-815-S1	38	ZSTN 147	47
MO-68/10	61	MT-817-C	38	ZSTN 181	47
MO-68/15	61	MT-840/1	38	ZSTN 75-116	47
MO-71	61	MT-841	38	ZVAT DC IND	14
MP-01	54	MT-843	20/46	ZVATDAC 25 SNCF	11
MP-02	54	MT-847	46	ZVATDC 2000 HS	36
MP-100/03-10	54	MT-848	19	ZVATDC 2000 RS	36
MP-100/03-5	54	MT-852	46	ZVATDC 3000 HS	36
MP-100/04-10	54	MT-853	46	ZVATDC 3000 PS	36
MP-100/04-5	54	MT-8601	40	ZVATDC 3000 RS	36
MP-100/05-10	54	MT-8602	40	ZVATDC 4000 HS	36
MP-100/05-5	54	MT-8612	40	ZVATDC 4000 RS	36
MP-100/10-10	54	MT-8614	40	ZVATDC 750/1500W	14/25
MP-100/10-5	54	MT-895	44	ZVDCAL 750 TROL	27
MP-42/11*	54	MT-9801	39	ZVISIOCAT	67



# Products Index

	Page(s)		Page(s)
<b>A</b>		<b>J</b>	
Access points	47	Insulating sticks for short-circuiting and earthing systems	15/43
Adjusted fixed points	47	Insulating sticks for voltage detectors	16/48
Anti fall device	63	Intervention kit for substation	30/31
Arc flash equipment	60	Intrinsically safe torch light	31
<b>B</b>		<b>L</b>	
Bags for insulating mats	54	Jumper cable	33
Bags for insulating sticks	16	Ladders	64
Bipolar detector for a.c./d.c. networks	37	Lamps (safety)	31
Bipolar voltage detectors for catenaries working	13	Lanyards	62
Boots insulating	54	Low voltage detectors	32
<b>C</b>		Low voltage short-circuiting system	33
Cables (copper) for catenaries working	18	<b>M</b>	
Carrying and storage stick case	15	Mats insulating	54
Carrying bags for short-circuiting systems	44	Medium voltage detectors	34/35
Carrying box for rubber gloves	52	Multiple locking apparatus	56
Case for insulating sticks	43	Multi-tester (Low voltage)	32
Catenary inspection equipment	67	<b>O</b>	
Chain delineators	30/58	Overglasses	50
Clamp (auto clamping) for tramway installations	26	Overgloves	52
Clamps for high voltage	42	<b>P</b>	
Clamps for medium voltage installations	38	Padlocks with warning signs	56
Clamps for single and double catenary	17/18	Platforms insulating	53
Climbers	64	<b>R</b>	
Compact carrying kit (safety equipment)	65	Rescue stick	53
Connection adaptors	65	Rope safety	62
Connection adaptors for insulating sticks	44	Rubber gloves storage box	52
Constraint tie	63	Rubbergloves (insulating)	51
Consumers units system	33	<b>S</b>	
Copper cables for HV installations	46	Safety boundary post	30/58
Coppers cables for catenaries working	18	Safety equipment	30/31
<b>D</b>		Safety glasses	50
D.C electronic voltage detector for catenaries working	13/14	Safety lamps	31
Delineators	10/30/58	Self adhesive warning signs	57
<b>E</b>		Set of sticks for short circuiting and earthing systems	43
Earth clamps for catenaries working	19/20	Short-circuiting and earthing systems (medium voltage)	39
Earth clamps for HV installations	46	Short-circuiting and earthing systems for switchgear	40
Earth clamps for medium voltage installations	38	Signal for working sites	65
Earth clamps for tramway installations	26	Single pole breaker lockout	56
Earthing kit support	44	Single pole phase comparator	37
Earthing rail equipment for subway installations	28	Snap hooks	62/63
Earthing rail equipment for tramway installations	26	Specialized signs	58
Earthing rail equipment for trolley installations	27	Stand by device	40
Earthing roller	66	Stick bags	16
Electronic voltage detectors for catenaries working	11/12	Stick covers	16
Equipment for working on pole	61/62/63	Sticks for short-circuiting and earthing systems (HV)	44
Extended clamps for HV substations	45	Sticks for short circuiting and earthing systems (MV)	43
Extinguishers	31	Sticks (telescopic) for earthing systems	15
<b>F</b>		Sticks (telescopic) for voltage detectors	48
Face shield	50	Switch clamps	45
Fall arrester	62	<b>T</b>	
Fixed ball points	38	Telescopic sticks	16/25
Fixed points H.V.	47	Telescopic insulating stick for multipurpose use	48
<b>G</b>		Two pole phase comparator	37
Glasses (safety)	50	<b>U</b>	
Gloves	51/52	Undergloves	52
Gloves tester	52	<b>V</b>	
<b>H</b>		Voltage detector for subway installations	28
Handle with 6 padlocks	56	Voltage detector for tramway installations	25
Harness	61	Voltage detector for trolley installations	27
Headlamps	51	Voltage detectors for catenaries working	11/12/13/14
Helmets	50	Voltage detectors high tension	41
High voltage clamps	42	Voltage detectors medium voltage d.c.	36
High voltage detectors	41	Voltage detectors medium voltage a.c.	34/35
HV substation extended clamps	45	<b>W</b>	
<b>I</b>		Wall mounted supports	48
Insulating boots	54	Warning flags	10/30/58
Insulating ladders	64	Warning signs	10/57/58
Insulating mats	54	Working gloves	52
Insulating platforms	53	Working on pole kits	63
Insulating rubber gloves	51		
Insulating sticks for HV short circuiting systems	44		

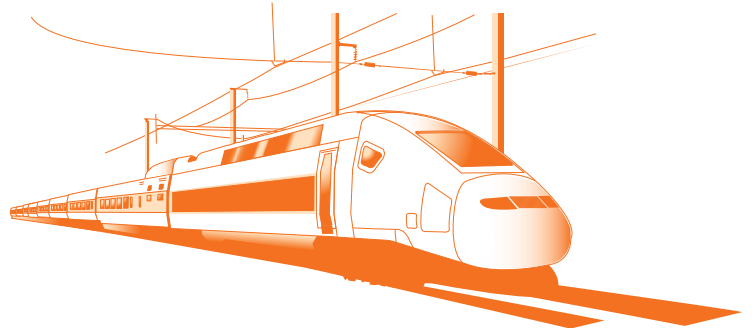

# Equipment for intervention on catenaries

COMPLETE EQUIPMENT GUIDE

8

WARNING SIGNS

10

VOLTAGE DETECTORS

11

INSULATING STICKS

15

SHORT-CIRCUITING AND EARTHING SYSTEMS

17



# Equipment for intervention on catenaries

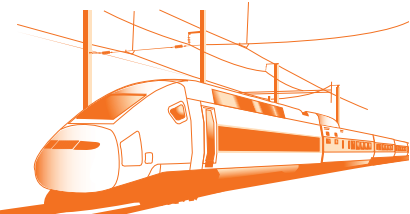

## COMPLETE EQUIPMENT GUIDE

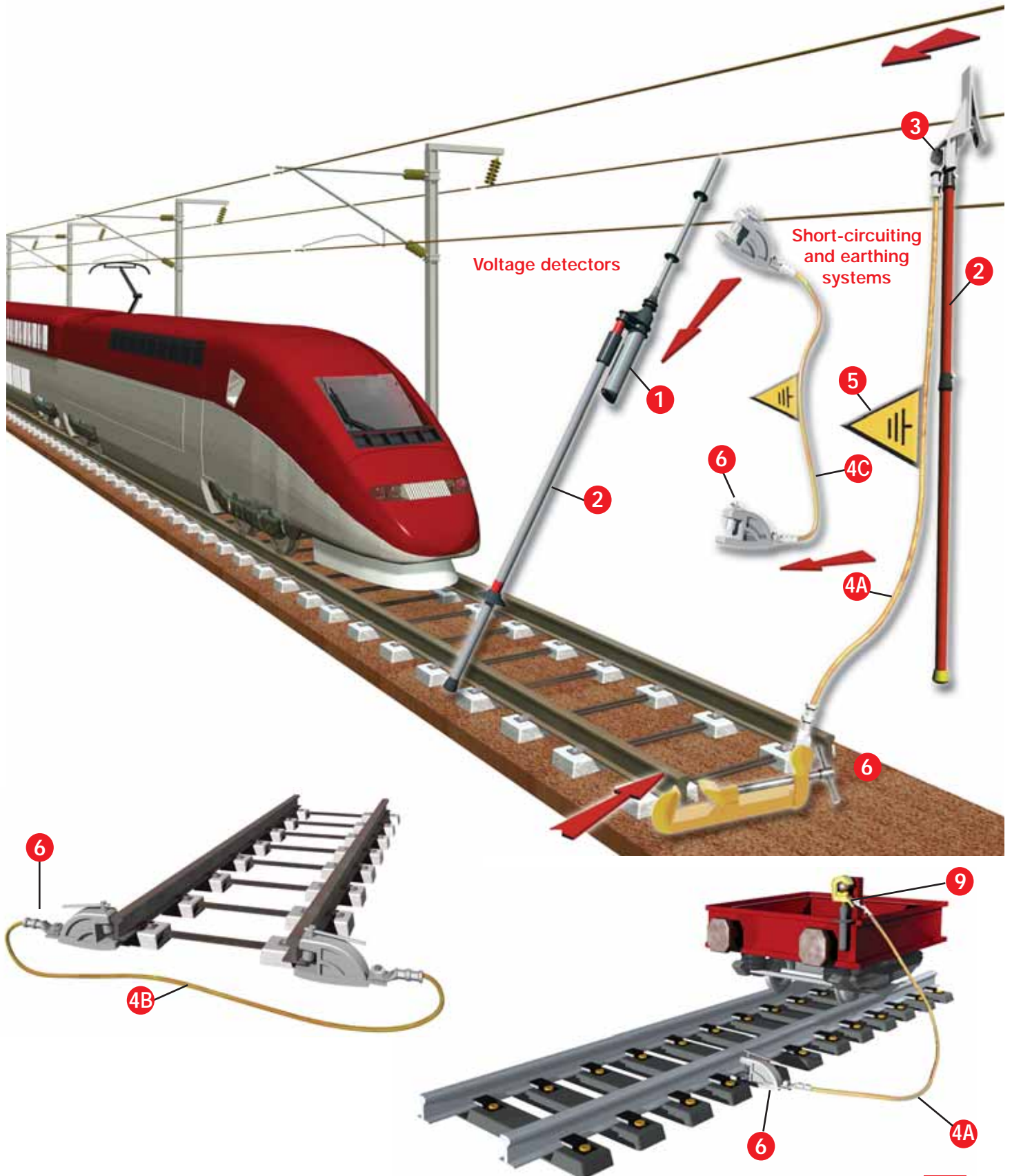





# Equipment for intervention on catenaries

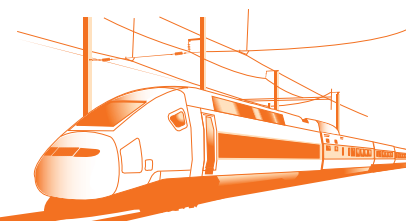

## COMPLETE EQUIPMENT GUIDE

\* For other voltages, please consult us

Voltage detectors*			
a.c.		d.c.	
15 kV	25 kV	1500 V	3000 V
<b>1</b> Electronic voltage detector 15 kV 16 Hz 2/3 reference: CC-578-15  See page <span style="float:right">11</span>	Electronic voltage detectors 25 kV 50/60 Hz references: CC-875-25-C CC-875-25-K  See page <span style="float:right">12</span>	Electronic voltage detector 600/2000 V reference: CC-1515-100  See page <span style="float:right">13</span>	Electronic voltage detector 750/3000 V reference: CL6-3000  See page <span style="float:right">13</span>
	Railway detector 25 kV Hz alternative catenary reference: ZVATDAC 25 SNCF  See page <span style="float:right">11</span>	Electronic voltage detector 750/1500 V reference: ZVATDC 750/1500 W  See page <span style="float:right">14</span>	Bipolar voltage detector with discrimination of induced voltage 750/3000 V reference: ZVAT DC IND  See page <span style="float:right">14</span>
Insulating sticks for voltage detectors and short-circuiting systems			
<b>2</b> Insulating sticks with connectable elements references: CM-42.... serie                      CM-4620.. serie CM-43.... serie                      CM-4625.. serie CM-4610.. serie                      CM-3000 CM-4615.. serie  See page <span style="float:right">15</span>		Insulating telescopic sticks references: CE-5-50-C, CE-5-50-K, ZPTVZCR 5603, ZPTVZCR 5603 B, ZRAVZC 200  See page <span style="float:right">16</span>	
		Accessories Stick bags references: CM-1.., CM-2.., CM-3.. series  See page <span style="float:right">16</span>	
Short circuiting and earthing systems			
Clamps			
<b>3</b> Universal clamp references: ZCCVZC 25, ZCCVZC 25 B, ZCCVZC 25 1  See page <span style="float:right">17</span>		Clamps with or without fuse contact wire references: MT-128, ZEMRC 200 B, ZEMRC 201 B  See page <span style="float:right">17/18</span>	
Clamps for flat and round conductors references: MT-128, MT-815-E  See page <span style="float:right">17/18</span>		Clamps for single or double catenary reference: ZEMCC-3162-BC, ZEMRC 300 B, ZEMRC 301 B  See page <span style="float:right">17/18</span>	
Cables with connections			
a.c.		d.c.	
15 kV	25 kV	1500 V	3000 V
<b>4A</b> reference: M-24-35-S - 8 kA/1s, section: 35 mm <sup>2</sup>		reference: M-24-70-S - 16 kA/1s, section: 70 mm <sup>2</sup>	
<b>4B</b> reference: M-24-40-S - 10 kA/1s, section: 40 mm <sup>2</sup>		reference: M-24-95-S - 20 kA/1s, section: 95 mm <sup>2</sup>	
<b>4C</b> reference: M-24-50-S - 12 kA/1s, section: 50 mm <sup>2</sup>			
See page <span style="float:right">18</span>		See page <span style="float:right">18</span>	
<b>5</b> Accessory: earth flag reference: AL-58, AL-60  See page <span style="float:right">10</span>			
Earth clamps			
<b>6</b> Earthing rail clamps references: MT-848, ZSMT-848/100, ZETMRTO, ZET-62042  See pages <span style="float:right">19/20</span>		<b>9</b> Earth clamps for fixed ball points references: MT-1911, MT-1921, for round and flat conductor: MT-843 for clamping on pole Z-EMCT847 SNCF  See page <span style="float:right">20</span>	

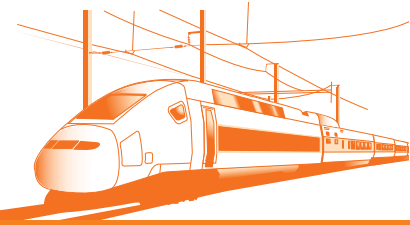

## WARNING SIGNS AND DELINEATORS

### Warning and specialized signs

#### Warning signs

Reference	Type	Dimensions	Characteristics
AM-41/1*	Aluminium	100 mm side	Black on yellow Fixing: 3 holes Ø 4.5 mm
AM-49/1*	Aluminium	100 mm side	Black on yellow Fixing: 3 holes Ø 4.5 mm
AM-344-GB	Aluminium	100 mm side	Black letters on yellow Fixing: 3 holes Ø 4.5 mm
AM-345-GB	Aluminium	100 mm side	Black letters on yellow Fixing: 3 holes Ø 4.5 mm

\* Pack of 10 units.

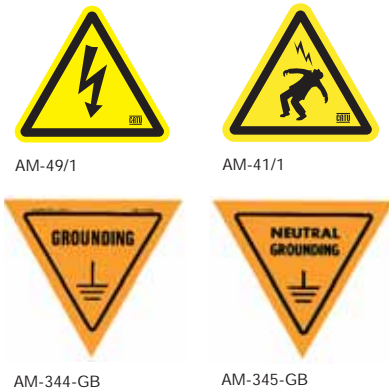

#### Specialized signs

Reference	Type	Dimensions (mm)	Characteristics
AM-20-GB	Aluminium	350 x 250	Blue letters on plain aluminium
AM-20-RM	Aluminium	350 x 500	Blue letters on plain aluminium
AM-61-GB	Aluminium	150 x 200	Black on yellow on plain aluminium



AM-20-GB



AM-20-RM



AM-61-GB

### Warning flags



AL-58	Attached on handle; for work site
AL-60	To be attached on earthing cable; for immediate identification in open-type switchgears possible inscription: 0 to 99 (by using ALU-SCRIPT markers)

### Safety boundary post

For temporary installation. Used with tough chain link delineators (AL-32/05). Removable foot. Ø 50 mm. Length: 0.9 m.



AL-316	Red and white - Weight: 4.2 kg
AL-318	Black and yellow - Weight: 4.2 kg

### Chain delineators

Polyamide chains.



AL-31/25	Red and white - Length: 25 m
AL-32/05	Yellow and black - Length: 5 m

### Delineators

Brightly colored ribbon. Snap hook on one ribbon end and another on spool. A ring on spool brakes ribbon at desired length. Wide: 50 mm. Length: 20 m.



AL-62-A	Red ribbon
AL-63-A	Yellow ribbon



# Equipment for intervention on catenaries

a.c.

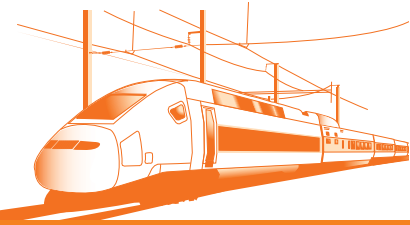

## VOLTAGE DETECTORS

### Electronic voltage detector with contact electrode extension 15 kV 16 Hz 2/3

- Voltage presence is indicated by:**
- red flashing LED'S (very bright - visible at more than 50 m in direct lighting)
  - powerful rated audible signal > 60 dB (A)/2 m
- IEC-61243-1  
DIN VDE 0682-411  
CE

**Check of working order:**

- by pressing the TEST button:
  - red LED flashes on
  - sound signal is activated
- when TEST button is released:
  - timed green LED lights up. While remaining on, this LED indicates the good working order of the detector. It lights off as soon as the red LED lights up in case of a voltage presence.

This checking validates the good working order of the detector.

**Characteristics**

Detectors are adjusted, tested and controlled one by one. Precise and stable operating threshold. Reduced sensitivity to induced voltages. Dielectrically tested on substation bars. High environmental resistance (impacts, vibrations, moisture). Temperature conditions: class N (IEC-1243-1 standard). storage and operation: -25 / +55 °C. Robust housing. Power supply: one 9-V alkaline battery type 6 LR 61. The voltage detector is always ready for use, since it is on continuous monitoring conditions with almost no battery consumption. Under normal use conditions the batteries last more than a year. Contact electrode extension fitted to the housing by screwing. Delivered complete in a bag with insulating stick. Weight: 1.7 Kg.

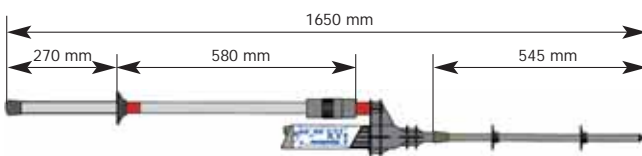

Reference	Voltage (kV)	Frequency (Hz)
CC-578-15	15	16-2/3

### Electronic voltage detector 25 kV

**Operation**

Single pole voltage detector used to check the voltage state of a railway electrical catenary system. The detector must be used with the insulating sticks assembled.

**Voltage presence is indicated by:**

- Bring the hook into contact with the catenary or the feeder:
- The presence of voltage is indicated by illumination of the red diodes and triggering of the sound signal.
  - The absence of voltage is confirmed by the green diodes, which remain illuminated after the contact is established.

**Check of working order:**

- To check for correct operation:
- by pressing the Test button:
    - illumination of the red diodes
    - triggering of the sound signal
  - by releasing the test button:
    - illumination of the green diodes for about 2 minutes.
- This checking validates the good working order of the detector.

**Characteristics**

- 1 voltage detector fixed on a 1.5 m stick.
- 1 antenna, length 1.5 m.
- 1 base element sticks, length 1.5 m.
- 2 extension sticks, length 1.5 m each.
- 1 silicone cloth.
- 1 pair of insulating gloves CG-30D (see p 51).
- 1 carrying bag.

**Power supply**

Power for the appliance is provided by a 9 volt, 6 LR 61 type battery.



Reference	Frequency (Hz)	Operating voltage (kV)	Weight (kg)
ZVATDAC 25 SNCF	50	25	12**

\*\* Total weight with stick, gloves, antenna and detectors.



# Equipment for intervention on catenaries *a.c.*

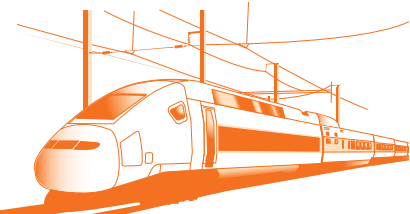

## VOLTAGE DETECTORS

### IEC electronic Voltage Detectors, "Compact serie" for indoor and outdoor use

Ultimate technology of voltage detector "Head Capacitive Technology"

IEC-61243-1



**Compact and light**

**It offers:**

- a wide band (25 kV)
- a universal application (50/60 Hz)

**Voltage presence is indicated by:**

- red flashing LED (very bright -visible at more than 20 m in direct lighting)
- powerful rated audible signal > 60 dB(A)/2 rn

**Operating check:**

By pressing the TEST button, correct operation is indicated as follows:

- a red LED flashes on
- sound signal

(during and after this test, the timed green LED lights up. While remaining on, it indicates the good working order of the detector)

**Characteristics:**

- Detectors have unitary adjustment and are checked by routine test
- Dielectrically tested on substation bars (bridging test)
- Precise and stable operating threshold
- Reduced sensitivity to induced voltages
- Reduced sensitivity to interference field
- High environmental resistance (impacts, vibrations, moisture)

Use from 50 to 60 Hz

Temperature conditions: class N (IEC-61243-1 standard).

Storage and operation: -25 / +55 °C

Robust housing.

Power supply: 1 x 9V alkaline battery type 6 LR 61

Contact electrodes fitted to the housing by screwing and are easily interchangeable.

**End fittings:**

C = hexagonal 12 mm, for hexagonal end-fitting sticks.

K = universal, for universal end-fitting sticks.

Weight of the detector: 420 g

Size of the detector: Ø 59 x 270 mm

Packaging: unit supplied complete in a case with batteries and contact electrodes.

Total weight: 1.1 kg

Total size: 340 x 275 x 83 mm

\* Specify type of mounting when ordering: C or K.

**Recommended stick:**

CE-5-50, see page 16.



CC-875-25\*



Frequency 50/60 Hz	
Reference	Operating voltage (KV)
CC-875-25*	25

\* Specify type of mounting when ordering: C or K.

For other voltages, please consult us.

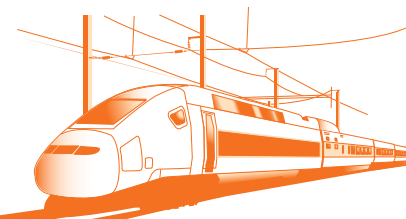

## VOLTAGE DETECTORS

### d.c. bipolar voltage detector 0.6 to 2 kV

#### Operation

Two-pole voltage detector for the presence of voltage between the catenary and the rail

- Presence of voltage is indicated by:
  - illumination of 6 red LEDs
  - an audible signal (60 dbA/2 m)
- Correct operation check: Correct operation of the equipment is verified:
  - by pressing the test button which causes:
    - Illumination of the 6 red LEDs
    - Activation of the audible signal and
  - by releasing the test button which causes:
    - temporary illumination of 6 green LEDs

The correct operation check consists in a built-in device. It checks all of the detector's functions.

Stand-by state

No previous voltage adjustment required

Routine operations in factory to adjust and test the equipment

Detector fixed to stick, attachment to rail by metal spring-contacts

Power supply: 1 x 9V alkaline battery, type 6 LR 61

Stick included in pack: CC-1515-101

Supplied in carrying case: CM-303.



CC-1515-100

Reference	Operating voltage (kV)	Weight (kg)
CC-1515-100	0.6 to 2 d.c.	5.2

### Telescopic insulating stick



Telescopic insulating stick, 3 elements, fully folded/extended: 1.65 x 3.95 m, including:

- Regulation piece of intermediary position.

Reference		Voltage (KV)
CC-1515-101	Stick	0.6 - 1.5
CC-1515-102	Antenna	0.6 - 1.5

### d.c. voltage detector 0.75 to 3 kV acoustic and optical signal

#### Operation

Two-pole voltage detector for the presence of voltage equipped with a flexible cable terminated by a contact clamp.

- Presence of voltage is indicated by:
  - illumination of 6 red LEDs
  - an audible signal (60 dbA/2 m)
- Correct operation check:

Correct operation of the equipment is verified:

- by pressing the test button which causes:

- Illumination of the 6 red LEDs
- Activation of the audible signal

and

- by releasing the test button which causes:
  - temporary illumination of 6 green LEDs

The correct operation check consists in a built-in device. It checks all of the detector's functions.

- Characteristics:

No previous voltage adjustment required

Routine operations in factory to adjust and test the equipment

- Power supply: 1 x 9V alkaline battery, type 6 LR 61

- Packaging in plastic case

- Weight: 1.5 kg

- Cable length: 8 m

Recommended stick: ZPTVZCR 5603 B, see pages: 16/27.



Reference	Field of use	Fitting	Contact-piece	Total length (mm)
CL6-3000	750-3000	B	Hook	450



# Equipment for intervention on catenaries

d.c.

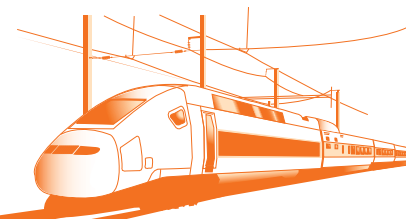

## VOLTAGE DETECTORS

### d.c. bipolar voltage detector with discrimination of induced voltage 0.75 to 3 kV

#### Characteristics:

Two-pole voltage detector to indicate the presence of voltage between the catenary and the rail.  
 There are a lot of interference voltages on catenary lines which come from other lines situated at proximity. This could create, especially when the weather is humid or when there are air pollution, VERY BIG induced voltage. This detector discriminate the real voltage from the induced one.  
 10 meters of cable.  
 Hook for catenary contact.  
 Magnetized handle for an easy use and connection to the rail.

#### Voltage presence is indicated by:

- Presence of real voltage indicated by:
  - Illumination of red LEDs with acoustic signal.
- Presence of induced voltage is indicated by:
  - Illumination of green LEDs and flashing of orangous LEDs with acoustic signal.

#### Checking

Connect the electrode to the rail handle to have a ring contact and the result is satisfactory if:

- When pressing the test button:
  - The red and orangous diodes lighting with acoustic signal sounding.
- When releasing the test button by:
  - Timed green LEDs lights up. It indicate the good working of the detector and it lights off as soon as the red LED lights up in case of a voltage presence or after 2 minutes.

**Power supply:** 1 x 9 V alkaline battery, type 6 LR 61.

**End fittings:** round threaded brass M25.00 x 3.5 or other on request.

**Packaging:** carrying bag.

**Weight:** 1.5 kg.

Recommended stick: ZPTVZCR 5603, see page 16.

**Other models or configurations:** contact us.



Reference	Field of use	Contact-piece	Cable length (m)
ZVAT DC IND	750-3000	Hook	10

### d.c. voltage detector 0.75 to 1.5 kV acoustic and optical signal

#### Characteristics:

Two-pole voltage detector for the presence of voltage equipped with a flexible cable terminated by a magnetic clamp.  
 8 meters of cable.  
 Hook for catenary contact.  
 Magnetized handle for an easy use and connection to the rail.

#### Voltage presence is indicated by:

- illumination of 6 red LEDs with accoustic signal.

#### Checking

Correct operation of the equipment is verified:

- by pressing the test button which causes:
  - illumination of the 6 red LEDs.
  - activation of the audible signal.
- by releasing the test button which causes:
  - temporary illumination of 6 green LEDs.

The correct operation check consists in a built-in device. It checks all of the detector's functions. No previous voltage adjustment required. Routine operations in factory to adjust and test the equipment.

**Power supply:** 1 x 9 V alkaline battery, type 6 LR 61.

**Packaging:** plastic case.

**Weight:** 1.5 kg.

Recommended stick: ZPTVZCR 4603 W, see page 25.



Reference	Field of use	Fitting	Contact-piece	Cable length (m)
ZVATDC 750/1500W	750-1500	W	Hook	8

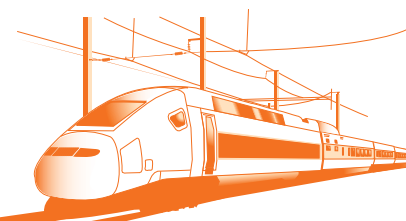

### Insulating sticks for short-circuiting and earthing systems

Made of IEC-60855 foam filled tube, these Ø 39 mm dia. elements are assembled using a new safety bayonet system connector in aluminium alloy. They allow construction of a large variety of custom made sticks that meet the most varied conditions of application. Calibrated lengths of 1 to 3 meters (with fraction of 0.50 m) permit a huge number of applications.

#### CM4000

Reference	Complete stick length (m)	Length (m)	Weight (kg)
<b>Basic elements</b>			
CM-4610	1		1.35
CM-4615	1.5		1.80
CM-4620	2		2.80
CM-4625	2.5		3.30
<b>Intermediate element</b>			
CM-4610-I	1		1.30
CM-4615-I	1.5		1.70
CM-4620-I	2		2.60
CM-4625-I	2.5		3.10
<b>Terminal elements</b>			
CM-4610-*	1		1.00
CM-4615-*	1.5		1.40
CM-4620-*	2		2.20
CM-4625-*	2.5		2.70
<b>Fixed length sticks</b>			
CM-4115-*	1		1.35
CM-4120-*	2		1.80
CM-4125-*	2.5		2.80
CM-4130-*	3		3.30
<b>Intermediate elements with rain</b>			
CM-4600-J	0.36		0.95

\* Add end piece C, K, E.

• With the smallest end fitting.  
•• With the biggest end fitting.

This range thus allows a stick-length limitation in case of space requirements and carrying capabilities.

IEC-60855

For common applications a serie of complete sets including 2 or 3 elements are made to give simple solutions for working distance from 2 to 6 meters.



### Carrying and storage stick case

Case especially designed for Ø 39 mm new range sticks. Carrying capacity: 3 elements.



CM-3000 480 x 330 x 120 mm - Weight: 1.2 kg

### Set of sticks

Complete sets of sticks for standard applications.

IEC-60855

Reference	Working distance (m)	Composition
CM-4220*	2	2 elements: CM-4610 + CM-4610-*
CM-4230*	3	2 elements: CM-4615 + CM-4615-*
CM-4240*	4	2 elements: CM-4620 + CM-4620-*
CM-4330*	3	3 elements: CM-4610 + CM-4610-I + CM-4610-*
CM-4345*	4.5	3 elements: CM-4615 + CM-4615-I + CM-4615-*
CM-4360*	6	3 elements: CM-4620 + CM-4620-I + CM-4620-*

\* Add end piece C, K, E.

*For cables < 95 mm<sup>2</sup> CM-4000 serie is recommended.*

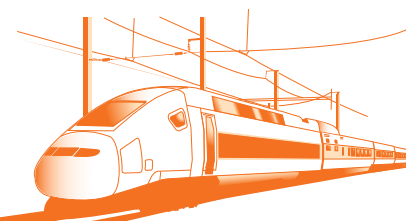

### Telescopic sticks for voltage detectors

**Telescopic stick** for use in checking for absence of voltage or electrical operation on installation or equipment IEC-61235

• Description:

- 4 yellow epoxy reinforced fibre-glass insulating sections, diameters 28 mm, 33 mm, 37 mm and 43 mm each section is fixed in position by a black plastic, spring-mounted button
- end-fittings: K = Universal (notched type)  
C = Hexagonal (hexagonal with 12 mm/flats)
- button cap: fixed made of elastomer material

Intermediate positions: length = 2.65 m / 3.85 m

**Other models or lengths: contact us.**



Reference	Length		Weight (Kg)	Elements n°
	Fitting	extended (m)		
CE-5-50-C	C	5.03	1.46	4
CE-5-50-K	K	5.03	1.46	4

### Telescopic sticks

**ZPTVZCR 5603** IEC-61235

Adjustable multipoint telescopic stick for use in earthing and short-circuiting.

SNCF Symbol 0 392 6977

Description:

- 3 epoxy reinforced fibre-glass isolating sections:
- 1 red terminal tube, diameter 28 mm,
- 1 intermediate tube, diameter 37 mm,
- 1 red base tube, diameter 45 mm, equipped with a screwing attachment at the end protected by a removable cap, which allows the 2 m extension to be attached (reference ZRAVZC 200) each section may be set at the desired length, according to operating height, with lever clamping system using an excentric cam,
- 1 end-fitting: round threaded brass M 25.00 x 3.50 (stick ZPTVZCR 5603) or type B bayonet (stick ZPTVZCR 5603 B),
- button cap: removable made of elastomer material.

**Other models or lengths: contact us.**

**ZRAVZC 200**

Lower extension for telescopic stickserie ZPTVZCR 5603. Epoxy reinforced fibre glass insulating section Ø 45 mm of red colour.



Reference	Length (mm)		Weight (kg)	Elements N°
	extended	folded		
ZPTVZCR 5403	5.40	2.00	3.6	3
ZPTVZCR 5603	5.60	2.15	3.7	3
ZPTVZCR 5603 B	5.60	2.15	3.7	3
ZRAVZC 200		2.00	1.9	1

### Stick bags

Strong waterproof fabric, strap for carrying.



Reference	Max. stick length (m)
CM-1-10	1.30
CM-1-15	1.80
CM-1-20	2.40

### Stick covers

Can contain 5 simple elements.

Strongly waterproof fabric strap for carrying.



Reference	Elements length (m)	Overall dimensions (m)
CM-3-03	1.75	0.575 x 1.950
CM-3-04	2.00	0.575 x 2.450
CM-3-05	2.50	0.575 x 2.850
CM-3-06	3.00	0.575 x 3.400



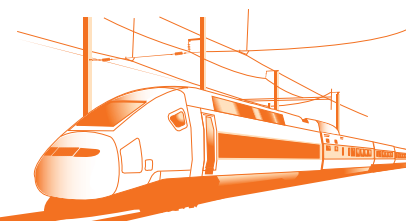

### Clamp for single or double catenary

Earthing clamp for single or double catenary, attached by clamping with operating sticks.

- Materials:
  - body: aluminium
  - clamping screw: hardened steel
- lcc: 30 kA/1 s
- Connection: for cables fitted with screw terminal diam.12 mm
- Clamping capacities:
  - double catenary: diam. 12/14 mm, distance between axes 25 mm
  - single catenary or conductors: diam. 5/35 mm, 16/40 mm, 5/40 mm
- End-fitting: bayonet type
- Recommended sticks: CM-46..E connectable ZPTVZCR 5603 B telescopic.



Reference	Weight (kg)	Dimensions (mm)	Conductors (mm)
MT-815-E	0.650	44 x 100 x 180	<ul style="list-style-type: none"> <li>■ 16-40</li> <li>● 5-35</li> <li>■ 5-40</li> </ul>

### Clamps for single or double catenary with quick opening and closing

Earthing clamp for single or double catenary, attached by clamping with operating stick.

- Opening and closing in one turn.
- Materials: all the components are in a light alloy.
- lcc: 50kA/25ms
- Clamping capacities:
  - single catenary: diam. 12/15 mm
  - double catenary: diam. 12/15 mm distance between axes: 80 mm maxi
- Connection for earth cable: screw diam.12 mm.
- End fitting: bayonet type.



Recommended stick: ZPTVZCR 5603 B, see pages: 16/27.

Reference	Dimensions (mm)	Weight (kg)	Specifications
ZEMRC 300 B	250 x 220 x 60	1.1	Without fuse contact wire
ZEMRC 301 B	250 x 220 x 60	1.1	With fuse contact wire

### Universal clamp for single or double catenary

Earthing clamp for single or double catenary, automatically attached by pressure from operating sticks.

- Materials:
  - body: aluminium
  - contact spring: hardened bronze
- lcc: a.c. = 12 kA/150 ms  
d.c. = 35 kA/25 ms
- Rate of current: 750 A/20 s
- Connection: for cables fitted with screw terminal diam.12 mm
- Clamping capacities:
  - double catenary: diam. 12/14 mm, distance between axes 50 mm
  - single catenary or tube: diam. 10/50 mm
- End-fitting: type round brass M 25.00 x 3.50
- Recommended stick: ZPTVZCR 5603 B
- SNCF symbol: 0.392.6325.



Reference	Weight (kg)	Dimensions (mm)
ZCCVZC 25	0.75	270 x 200 x 40
ZCCVZC 25 B	0.8	270 x 200 x 40
ZCCVZC 25 1	0.75	270 x 200 x 40

### Clamps for single or double catenary

Earthing clamp for single or double catenary, attached by clamping with operating stick  
Clamp equipped with a fuse contact wire

- Materials:
  - body: aluminium
  - quick-fix clamping screw: hardened steel
- lcc: 30 kA/1 s
- Connection: for cables fitted with screw terminal diam.12 mm
- Clamping capacities:
  - single catenary: diam. 10/22 mm
- End-fitting: bayonet type
- Recommended sticks: CM-46..E connectable ZPTVZCR 5603 B telescopic



Reference	Weight (Kg)	Dimensions (mm)	Specifications
ZEMRC 200 B	0.9	280 x 125 x 40	Without fuse contact wire
ZEMRC 201 B	0.9	280 x 125 x 40	With fuse contact wire

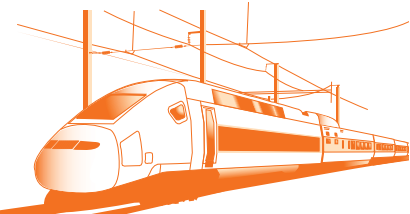

## CLAMPS, COPPER CABLES

### Clamp for single catenary

Body in aluminium alloy with trapezoidal threaded screw. Interposed elastic washers in the clamping system improve efficiency and insure a higher withstand in case of electrodynamic shock. Manœuvring by 4600 serie insulated stick of appropriate length and characteristics. Weight: 1.45 kg. Dimensions: h 200 x L 200 x thickness 50.



ZEMCC-3162-BC

Reference	Clamping capacity (Ø mm)	Rating insulation (kA/1 s)	Asymmetrical (A)	Copper connection		
				Copper cables (mm² max.)	Ø range (mm)	Stud or hole
ZEMCC-3162-BC	5-60	40	92	150	45	M 12

### Clamps for single or double catenary with fuse contact wire

Earthing clamp for single or double catenary, attached by clamping with operating stick. Clamp equipped with a fuse contact wire

- Materials:
  - body: aluminium
  - quick-fix clamping screw: hardened steel
- Icc: 30 kA/1 s
- Connection: for cables fitted with screw terminal diam. 12 mm
- Clamping capacities:
  - single catenary: diam. 10/22 mm
- End-fitting: bayonet type
- Recommended sticks:
  - CM-46..E connectable
  - ZPTVZCR 5603 B telescopic.



Reference	Weight (kg)	Dimensions (mm)
MT-128	1.3	260 x 160 x 70

### Copper cables

Transparent silicon sheath according to IEC-61230 . Resistant to temperature variations (-40 °C to +70 °C) with double IEC triangle marked on cable section.

IEC-61230	Rating (kA/1 s)	Weight (kg/m)	Cable Ø (mm)	Section (mm²)
M-24-35-S	8	0.386	9	35
M-24-40-S	10	0.440	9.5	40
M-24-50-S	12	0.545	10	50
M-24-70-S	16	0.768	12	70
M-24-95-S	20	1.000	14	95

For leads with double-crimped lugs, please consult us.



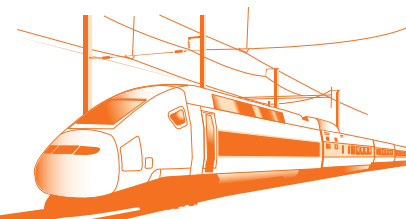

## EARTH CLAMPS, EARTHING RAIL CLAMPS

### Clamping on the edge

Rail earthing clamp for catenary, attached by manual tightening. Clamp for carrying out continuity shunt during the laying of a section of rail

- Materials:
  - body: aluminium
  - clamping screw: stainless steel
- Rate of current: 750 A/20 s
- Connection: for cables fitted with screw terminal diam.10 mm and diam.12 mm
- Clamping capacities:
  - clamping: clamped by lever. Electrical contact is maintained by spring washers. The contact quality is guaranteed by a plate with "diamond tip" shapes
  - capacities: vertical to the rail flange = 7 to 22 mm.
- SNCF symbol: 0.392.6481.

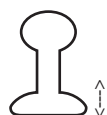

7 to 22 mm



Reference	Weight (Kg)	Icc	Dimensions (mm)
ZSMT-848/100	1.5	a.c. 15 kA/150 ms d.c. 52 kA/35 ms*	180 x 130 x 50

\* x 3 Shocks

### Clamping on the top of the rail

Earthing clamp for connection to the top of the rail and attached by manual tightening.

- Materials
  - Body & Clamping : aluminium
  - Contact : Brass
- Connection for cables fitted with screw terminal diam.12mm

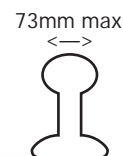

73mm max



Reference	Icc	Clamping capacities (Ø mm)
ZETMRTO	40 kA/120ms	73

### Clamping under the rail

Rail earthing clamp for catenary, attached by manual tightening

- Materials:
  - body: aluminium
  - clamping screw: stainless steel
- Connection: for cables fitted with screw terminal diam.12 mm
- Clamping capacities:
  - clamping: 1: 19 mm spanner used to clamp horizontally to the rail flange
  - 2: lever used to clamp to the rail flange. Electrical contact is maintained by spring washers
  - capacities: horizontal to the rail flange = 100 to 155 mm max.

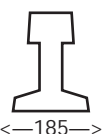

<—185—>

Vertical to the rail flange = 7 to 19 mm max.



MT-848

Reference	Weight (Kg)	Icc	Dimensions (mm)
MT-848	2.4	30 kA/1 s	320 x 150 x 75

Rail earthing clamp for catenary, attached by manual tightening.

- Materials:
  - body: ZET-62040: aluminium
  - ZET-62042: copper-aluminium
  - clamping screw: ZET-62040: stainless steel
  - ZET-62042: hardened steel
- Connection: for cables fitted with screw terminal diam.12 mm
- Clamping capacities:
  - clamping: clamped by lever.
  - capacities: horizontal to the rail flange = 100 to 160 mm max.

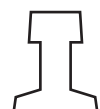

<—160—>



ZET-62042

Reference	Weight (Kg)	Icc	Dimensions (mm)
ZET-62040	1.680	30 kA/1 s	310 x 90 x 70
ZET-62042	2.0	30 kA/1 s	310 x 120 x 65

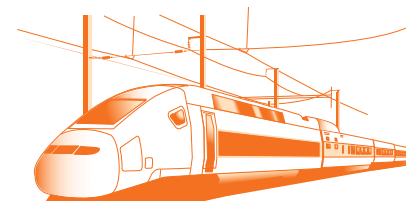

### Earth clamps

Earthing clamp for connection to rail / poles, attached by manual tightening

• Materials:

- body: cupro-aluminium
- clamping screw: stainless steel

Connection: for cables fitted with screw terminal diam.12 mm.



Reference	Rating insulation	Dimensions (mm) Weight (kg)	Connection	Clamping capacity (mm)
MT-843	40 kA/1 s	45 x 106 x 165 0.95	Hole: Ø 13	• Ø 6-35 — Ø 0-35

For fixed ball points



MT-1911  
MT-1921

For fixed point

Reference	Weight (kg)	Connection conductors (mm)
MT-1911	0.58 Ø 20 mm	Spheric fixed points <a href="#">MT-2951</a> Round conductors Ø 8 to 18 mm
MT-1921	0.69 Ø 25 mm	Spheric fixed points <a href="#">MT-3951</a> Round conductors Ø 10 to 25 mm

### Clamping on poles

Earthing clamp for connection to rail or poles and attached by manual tightening.

• Materials

- Body: cupro-aluminium
- Clamping : stainless steel

• Connection for cables fitted with screw terminal diam.12mm

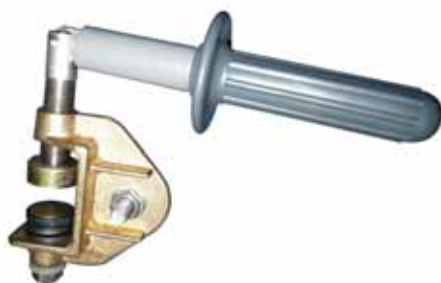

Reference	Icc	Clamping capacities (Ø mm)
ZEMCT 847 SNCF	30kA/0.5s	0 to 25 mm

**NEW RANGE OF BIMATERIAL INSULATED TOOLS**

## ISOMIL™ 2

1000 V CEI 60900 - EN 60900



**FOR LIVE WORKING UP TO 1000 VOLTS ACCORDING TO IEC 60900 STANDARD**

**CATU™**



# Equipment for intervention on electrical urban transports

COMPLETE EQUIPMENT GUIDE

22

VOLTAGE DETECTORS AND  
SHORT-CIRCUITING SYSTEM FOR TRAMWAY

25

VOLTAGE DETECTORS AND  
SHORT-CIRCUITING SYSTEM FOR TROLLEY

27

VOLTAGE DETECTORS AND  
SHORT-CIRCUITING SYSTEM FOR SUBWAY

28

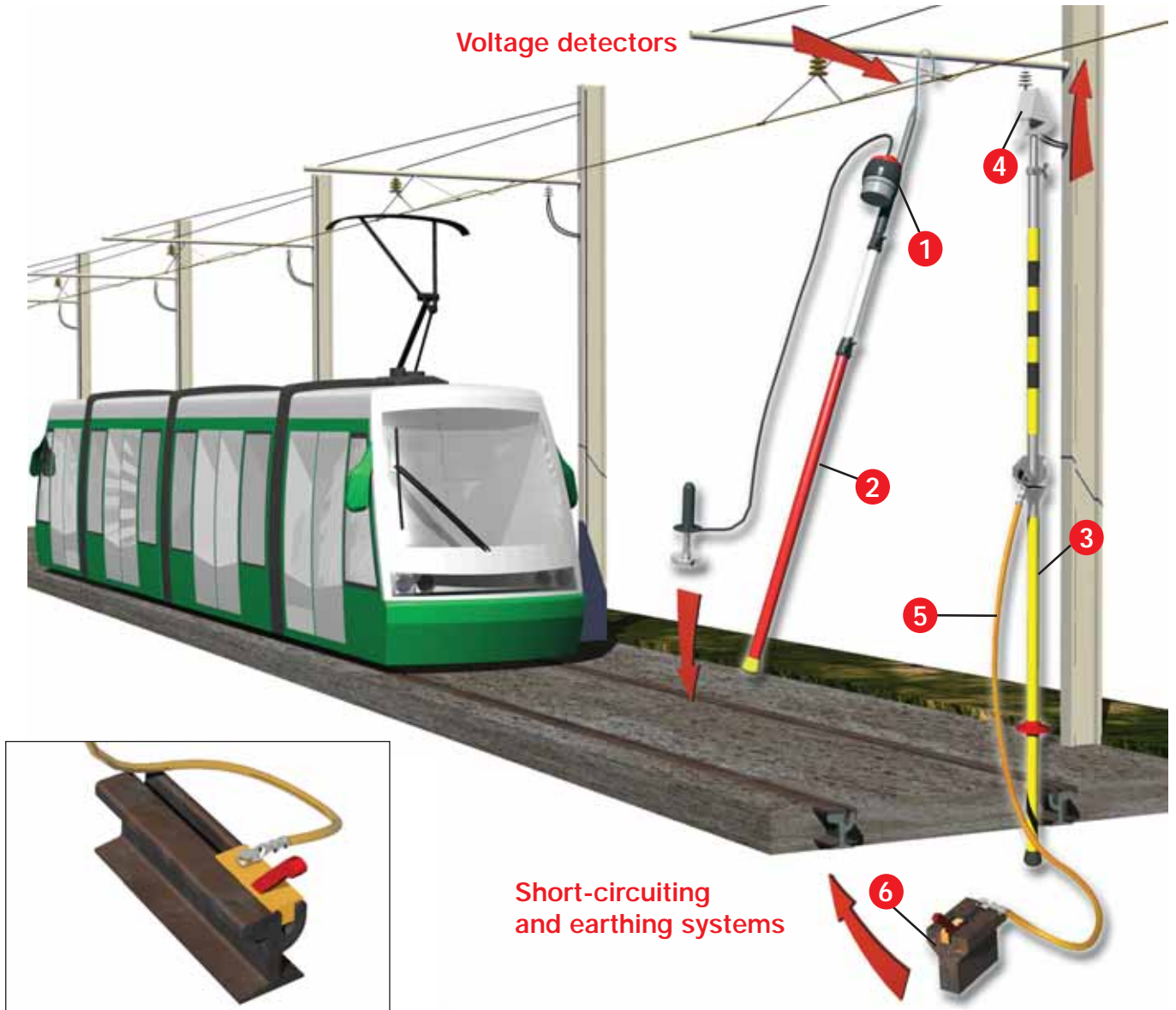

Voltage detectors

Short-circuiting and earthing systems



Voltage detectors		Short circuiting and earthing systems	
	<b>d.c.</b> 750/1500 V		Clamp
<b>1</b>	Bipolar electronic voltage detector reference: <a href="#">ZVATDC 750/1500 W</a>	<b>4</b>	Autoclamping contact clamp reference: <a href="#">ZEMCC 2160</a>
See page	25	See page	26
	Insulating sticks		Cables with connections
<b>2</b>	For voltage detector reference: <a href="#">ZPTVZCR 4603 W</a>	<b>5</b>	Copper cable with connection - Length: 2 m, section: 35 mm <sup>2</sup> reference: <a href="#">ZCESS 35/05 MR</a>
See page	25	See page	26
<b>3</b>	For short-circuiting system reference: <a href="#">ZPL7R 120N</a> , <a href="#">ZPTVZCR 5003</a>	<b>6</b>	Earth clamps
See page	26	<b>6</b>	Automatic earth clamps references: <a href="#">ZETMR 35</a> , <a href="#">ZETRT 35</a> , <a href="#">ZETMR 41</a> , <a href="#">ZETMR RG29</a> , <a href="#">ZETMR UNIV</a>
		See page	26

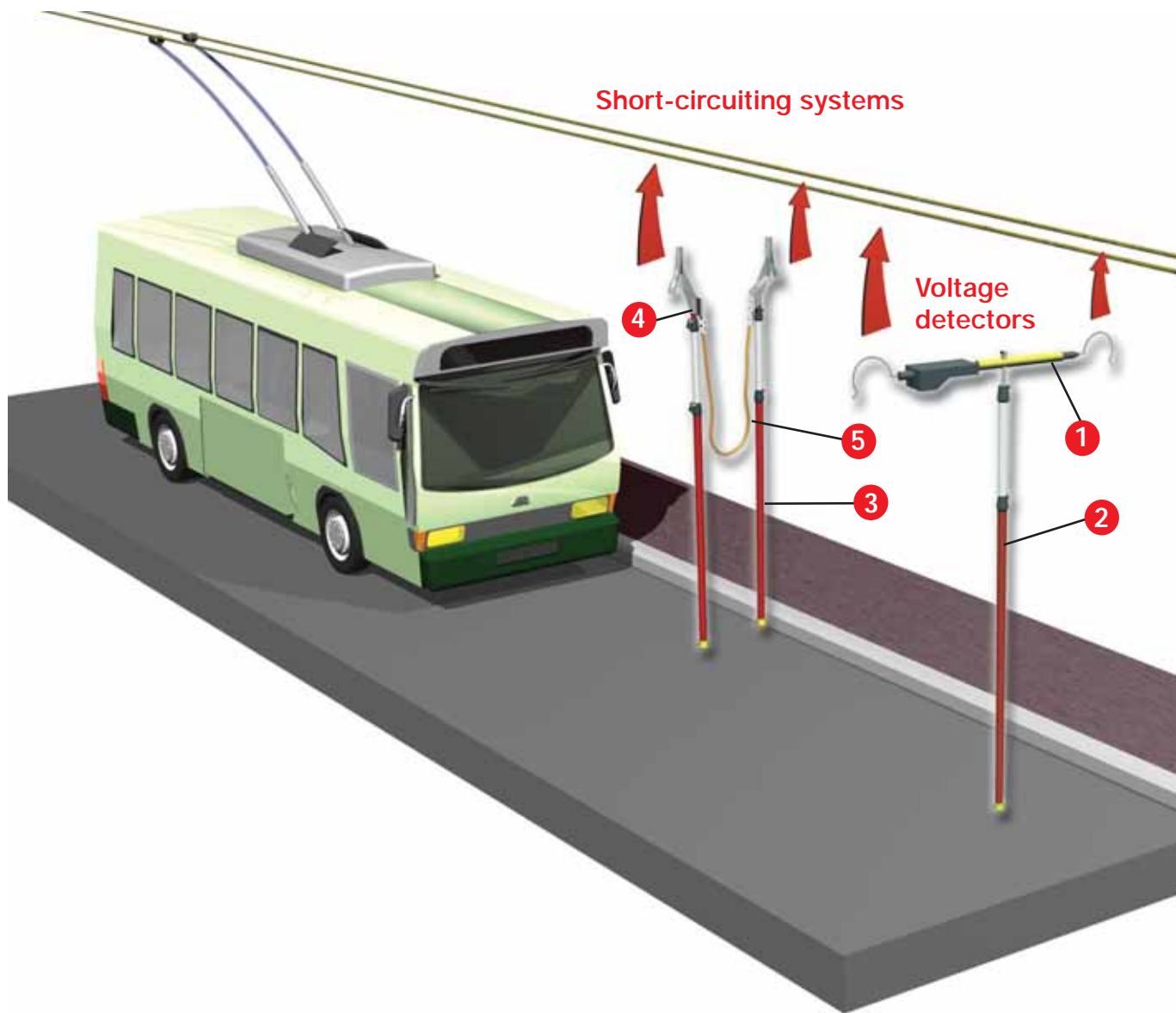

Voltage detectors		Short circuiting systems	
	<b>d.c.</b>		
	750 V		<b>Clamp</b>
<b>1</b>	Bipolar electronic voltage detector reference: ZVDCAL 750 TROL	<b>4</b>	Autoclamping contact clamp reference: ZCCVZC 25
	See page <span style="float: right;">27</span>		See page <span style="float: right;">27</span>
	<b>Insulating sticks</b>		<b>Cables with connections</b>
<b>2</b>	For voltage detector reference: ZPTVZCR 5603 B	<b>5</b>	Copper cable
	See page <span style="float: right;">27</span>		See page <span style="float: right;">27</span>
<b>3</b>	For short-circuiting system reference: ZPTVZCR 5603		
	See page <span style="float: right;">27</span>		

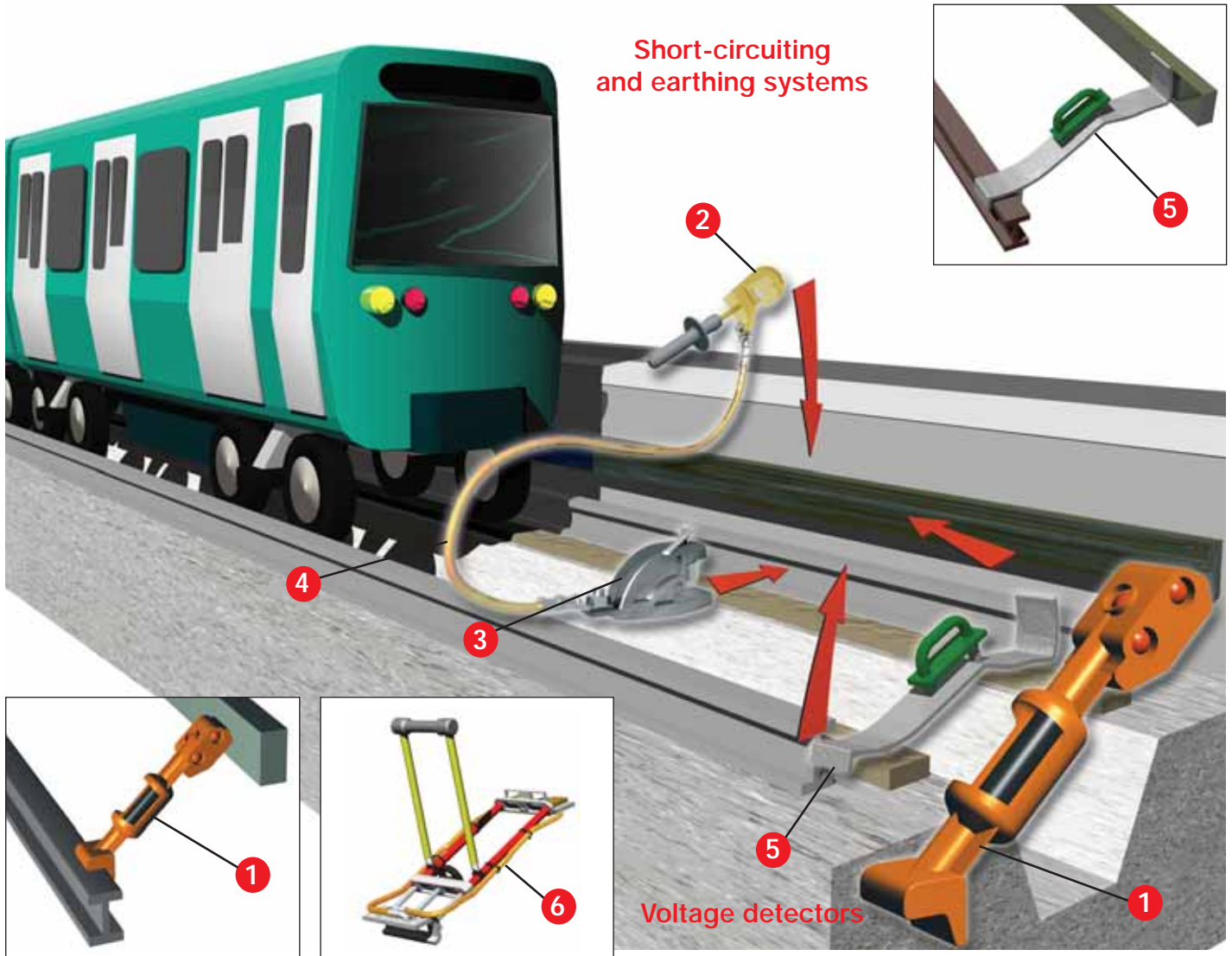

Short-circuiting and earthing systems

Voltage detectors

Voltage detectors	
	d.c. 750 V
<b>1</b>	Bipolar electronic voltage detector reference: CL-1607/1, CL-1607/ML See page <span style="float: right;">28</span>
Earthing equipment	
<b>5</b>	Earthing clamp for connection to the third rail reference: ZET 3R See page <span style="float: right;">28</span>
<b>6</b>	Earthing rail equipment for third rail configuration reference: MT-300 See page <span style="float: right;">28</span>

Short circuiting and earthing systems	
	Clamp
<b>2</b>	Clamp for side conductor references: MT-1921 See page <span style="float: right;">28</span>
	Cables with connections
<b>4</b>	Copper cable with connection reference: ZCESS-50-03 - Length: 3 m, section: 50 mm <sup>2</sup> See page <span style="float: right;">28</span>
	Earth clamps
<b>3</b>	Earth clamp for rail references: ZSMT 848/100 See page <span style="float: right;">28</span>





## VOLTAGE DETECTORS, EARTHING RAIL EQUIPMENT

### d.c. voltage detector 0.75 to 1.5 kV acoustic and optical signal

Two-pole voltage detector for the presence of voltage equipped with a flexible cable terminated by a magnetic clamp.

- Presence of voltage is indicated by:
  - illumination of 6 red LEDs
  - an audible signal (60 dbA/2 m)

- Correct operation check:

Correct operation of the equipment is verified:

- by pressing the test button which causes:

- Illumination of the 6 red LEDs
- Activation of the audible signal

and

- by releasing the test button which causes:
  - temporary illumination of 6 green LEDs

The correct operation check consists in a built-in device. It checks all of the detector's functions.

- Characteristics:

No previous voltage adjustment required

Routine operations in factory to adjust and test the equipment

- Power supply: 1 x 9V alkaline battery, type 6 LR 61
- Supplied in plastic case
- Total weight with case and magnetic clamp: 1,5 kg
- Cable length: 8 m

Recommended stick: ZPTVZCR 4603 W, see page 25.



Reference	Field of use	Fitting	Contact-piece	Total length (m)
ZVATDC 750/1500W	750-1500	W	Hook	8

### Telescopic sticks

#### ZPTVZCR 4603 W

Adjustable multipoint telescopic stick for use in earthing and short-circuiting.

IEC-61235

Description:

- 3 epoxy reinforced fibre-glass isolating sections:
  - 1 red terminal tube, diameter 28 mm,
  - 1 intermediate tube, diameter 37 mm,
  - 1 red base tube, diameter 45 mm, equipped with a screwing attachment at the end protected by a removable cap, which allows the 2 m extension to be attached each section may be set at the desired length, according to operating height, with lever clamping system using an excentric cam,
- 1 end-fitting: type W,
- button cap: removable made of elastomer material.
- delivered in a stick bag.



Reference	Length (m)		Weight (kg)	Elements N°
	extended	folded		
ZPTVZCR 4603 W	4.70	1.90	2	3



# Equipment for intervention on tramway installations



## VOLTAGE DETECTORS, EARTHING RAIL EQUIPMENT

### Earthing rail equipment

#### Clamps

Auto clamping contact clamp for catenary wire, fixed on top of a telescopic two elements metallic stick.  
 Folded / extended length: 1.80 / 3.25 m.  
 Bottom of metallic stick has a pin to be fixed on insulating stick.  
 Also on bottom a grounding braid clamp.

Reference	Weight (kg)	Length (m)
ZEMCC 2160	1.20	1.80 / 3.25

#### Insulating sticks

One part insulating stick, length 2 m.  
 Equipped on top with a "tulip" connector for ZEMC 2160 clamp.

Reference	Weight (kg)	Length (m)
ZPL7R 120N	2.00	2
ZPTVZCR 5003	2.00	1.80 / 5.00

#### Earthing rail clamps

Rail earthing clamp for 35 GTF rail (buried rail - streetcar).  
 Rail earthing clamp for catenary, attached by manual tightening.

- Materials:
  - body: copper-aluminium,
  - clamping screw: hardened steel 240 kg/mm.
- Connection: for cables fitted with screw terminal diam. 12 mm.
- Clamping capacities:
  - clamping: clamped by 1/4 turn lever. Electrical contact is maintained by an excentric cam,
  - capacities: clamps to the neck of rail type 35 GTF.

Reference	Weight (kg)	Icc	Rail type	Dimensions (mm)
ZETMR 35	1.2	8 kA/1 s	GTF 35	115 x 63 x 40
ZETMR 41	1.3	8 kA/1 s	GP 41 GPI 41	115 x 63 x 40
ZETRT 35	0.8	8 kA/1 s	GTF 35 GPI 41 RI 59	85 x 70 x 50
ZETMR RG 29	0.7	8 kA/1 s	RG 29	190 x 85 x 80
ZETMR UNIV	0.7	8 kA/1 s	ALL*	100 x 85 x 50

\* Magnetic clamping.

#### Copper cables

Flexible copper braid, silicon sheath (IEC-61230), with terminals.

Reference	Weight (kg)	Section (mm <sup>2</sup> )	Length (m)
ZCESS-35/05 MR	2.00	35	2

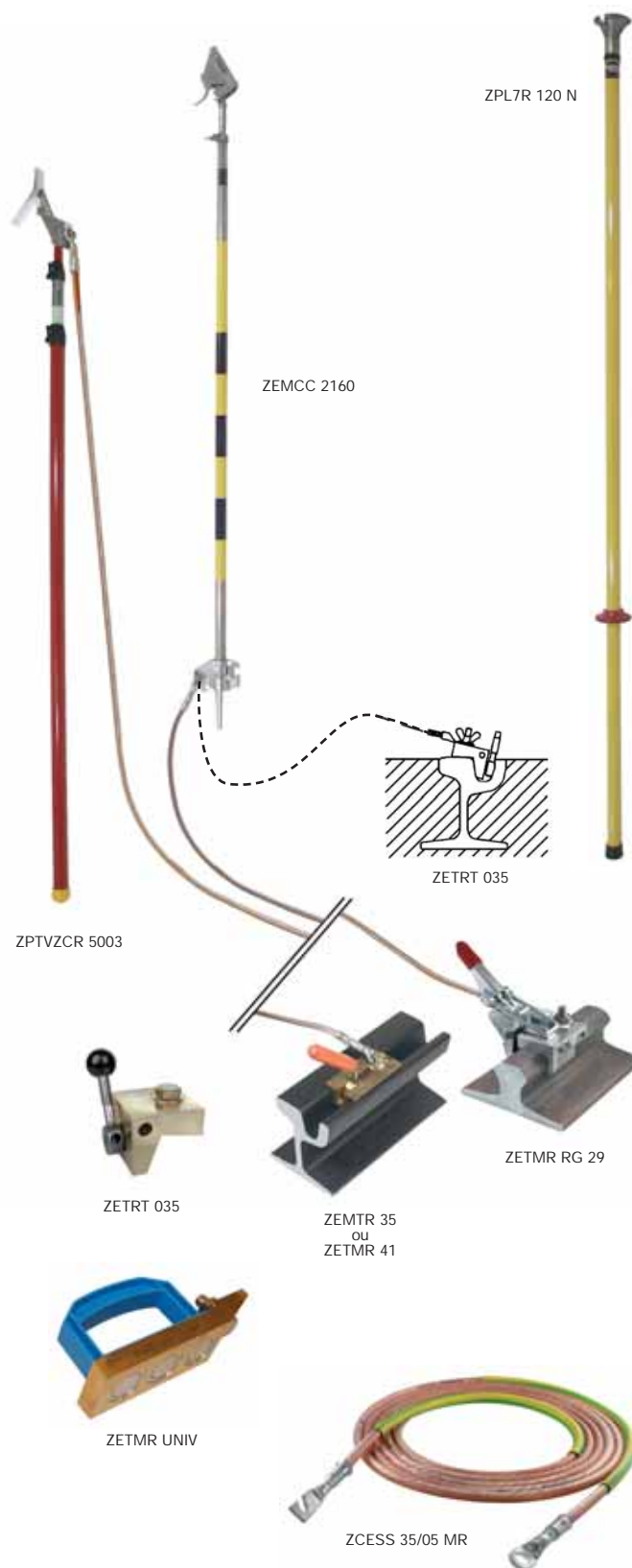



## VOLTAGE DETECTORS, EARTHING RAIL EQUIPMENT

### d.c. voltage detector 750 V

Two-pole voltage detector for presence of voltage between positive line and negative line, installation with a telescopic stick.

- Presence of voltage is indicated by:
  - illumination of 6 red LEDs
  - an audible signal (60 dbA/2 m)
- Correct operation check:

Correct operation of the equipment is verified:

- by pressing the test button which causes:

- Illumination of the 6 red LEDs
- Activation of the audible signal

and

- by releasing the test button which causes:
  - temporary illumination of 6 green LEDs.

The correct operation check consists in a built-in device.

It checks all of the detector's functions.

- Characteristics

Operating voltage: 750 V d.c.

Stand-by state.

No previous voltage adjustment required, any polarity.

Routine operations in factory to adjust and test the equipment.

Distance between line axes: 700 mm.

- Power supply: 1 x 9 V alkaline battery, type 6 LR 61.

Recommended stick: PTVZCR 5603 B.

Supplied in carrying case.

- Telescopic stick: ZPTVZCR 5603 B.

**Other models or configurations: contact us.**



ZVDCAL 750 TROL	Weight: 2.5 kg
-----------------	----------------

### Earthing rail equipment

- Universal earth clamp.

Icc = 35 kA / 50 ms.

For catenaries diameter 10 to 50 mm. see page 17

Reference	Weight (kg)	Dimensions (mm)
ZCCVZC 25	0.75	270 x 200 x 40

- Copper cables, flexible copper braid, silicon sheath (IEC-61230). See page 18.

- Telescopic stick. see page 14

Reference	Weight (kg)	Length (m)
ZPTVZCR 5603	3.7	2.15 / 5.60
ZPTVZCR 5603 B	3.7	2.15 / 5.60



## VOLTAGE DETECTORS, EARTHING RAIL EQUIPMENT

### d.c. voltage detector 750 V

Bipolar detector for d.c. networks:

- Built in testing device.
- Presence of d.c. voltage indicated by 5 red LED'S.
- Contact piece on rail: 3 contacts.
- Battery 4.5 V type 3 LR 12.



Reference	Dimensions (mm)	Weight (kg)
CL-1607/1	500	1.350
CL-1607/ML	535	1.900

Other models or configurations: contact us.

### Earthing rail equipment for third rail configuration

This equipment is designed to permit safe earthing and short-circuiting between the running rail and the railway lateral current rail.

- Materials
  - Aluminium contact block for current rail with guiding magnet and brass plate



Reference	Weight (Kg)	Icc	Dimensions (mm)
MT-300	10	85 kA/30 ms	900 x 300 x 125

### Earthing clamp for connection to the third rail

This equipment is designed to permit short-circuiting between the running rail and the railway lateral current rail.



Reference	
ZET 3R	Body: steel

### Clamping on the rail

- Rail earthing clamp for catenary, attached by manual tightening. Clamp for carrying out continuity shunt during the laying of a section of rail.
- Materials:
  - body: aluminium,
  - clamping screw: stainless steel.
- Rate of current: 750 A/20 s.
- Connection: for cables fitted with screw terminal diam.10 mm and diam.12 mm.
- Clamping capacities:
  - clamping: clamped by lever. Electrical contact is maintained by spring washers. The contact quality is guaranteed by a plate with "diamond tip" shapes,
  - capacities: vertical to the rail flange = 7 to 22 mm.
- SNCF symbol: 0.392.6481.



Reference	Weight (Kg)	Icc	Dimensions (mm)
ZSMT 848/100	1.5	a.c. 12 kA/150 ms d.c. 52 kA/35 ms*	180 x 130 x 50

\* x 3 shocks

### Earth clamp

For fixed point.



Reference	Weight (kg)	Connection conductors
MT-1921	0.69	Flat 18 mm - Ø 25 mm

### Copper cables

Flexible copper braid, silicon sheath (IEC-61230). See page 18.



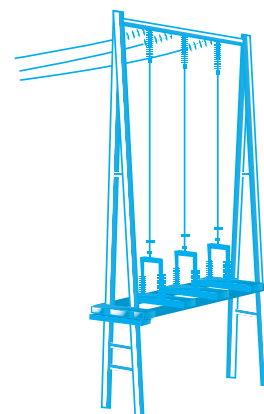

# Equipment for lines, substations and installations

**SAFETY EQUIPMENT**

**30**

**LOW VOLTAGE DETECTORS AND  
SHORT-CIRCUITING SYSTEMS**

**32**

**HIGH VOLTAGE DETECTORS AND  
SHORT-CIRCUITING SYSTEM**

**34**

**VOLTAGE DETECTORS AND  
SHORT-CIRCUITING SYSTEM**

**41**

**ACCESSORIES**

**43**

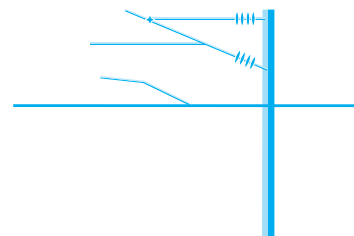

## DELINEATORS, SAFETY EQUIPMENT

### Warning flags



AL-58	Attached on handle; for work site
AL-60	to be attached on earthing cable; for immediate identification in open-type switchgears possible inscription: 0 to 99 (by using ALU-SCRIPT markers)

### Safety boundary post

For temporary installation.  
Used with tough chain link delineators (AL-32/05).  
Removal foot.  
Ø 50 mm.  
Height: 0.9 m.



AL-316	Red and white - Weight: 4.2 kg
AL-318	Black and yellow - Weight: 4.2 kg

### Chain delineators

Polyamide chains.



AL-31/25	Red and white - Length: 25 m
AL-32/05	Yellow and black - Length: 5 m

### Delineators

Brightly colored ribbon.  
Snap hook on one ribbon end and another on spool.  
A ring on spool brakes ribbon at desired length.  
wide: 50 mm  
length: 20 m.



AL-62-A	Red ribbon
AL-63-A	Yellow ribbon

### Intervention kits



#### Composition of the kits

Reference	Composition	Characteristics	Dimensions
CG-30-C	Insulating rubber gloves	26 500 V max	size 10
CG-35/1	Rubber gloves storage box with window		60 x 210 x 460 mm
CI-23	Fuse holder		90 x 240 x 260 mm
CS-45	Rescue stick	45 kV	1.65 m
CI-06-D	Wall mounted supports	Delivered with CS-45	
CT-7-25/1*	Insulating platform	24 000 V max	500 x 500 x 220 mm
MP-42/16**	Insulating MAT	≤ 26.5 kV	0.6 x 1 mm
KIT-01*	Intervention kit with insulating platform		
KIT-10**	Intervention kit with insulating mat delivered with a protective P.V.C. container		



# Lines, substations and installations

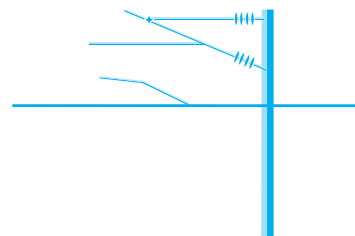

## DELINEATORS, SAFETY EQUIPMENT

### Extinguishers

Carbon dioxide for B and C type fires.



CD-302	Capacity: 2.68 L - 290 x 615 mm Weight full: 5.4 kg
CD-306	Capacity: 8.04 L - 320 x 870 mm Weight full: 14 kg

### Safety lamps

Emergency mobile lighting for MV indoor substations, rechargeable on 220 V.



CD-122	Adjustable flood beam - power beam: 5.5 W Operates: 3 hours - Weight: 1.2 kg
CD-124	Delivered with a wall mounted support Bulb: 6 W/12 W Operates: 1 hour (12 W), 2 hours (6 W) Rechargeable on 230 V 50/60 Hz 3 positions switch: Off, 6 W, 12 W 100 x 190 x 220 mm - Weight: 1.9 kg

### Intrinsically safe torch light

Protection mode EEx iae IIc T6 (suitable for all areas and gases).  
Appropriate certificates for Merchant Marine and VERITAS.  
Power supply by 1.5 V LR 20 batteries (x 2).  
Fixed light or intermittent optical signals.  
Double optical systems.



CD-104	Dimensions: 230 x 90 x 90 mm - Weight: 400 g
--------	----------------------------------------------

### Life saving kits for M.V. substations

#### Wall mounted KIT

In case of an electrical accident, quick response is essential: seconds gained or lost can decide the life or death of a victim.

Our life saving equipment is designed to make all necessary materials immediately available to rescue personnel.

It includes:

- 1 rescue telescopic stick
- 1 voltage detector with flexible antenna contact (with autotest)
- 1 cable cutter with insulated handles
- Forged steel blades maximum opening: 30 mm
- 1 insulating platform 24 or 36 kV
- high voltage Insulating gloves, insulating boots
- Safety instructions on the plastic board
- 1 talcum powder can.



CZ-54-R	Wall mounted panel 0.84 x 0.745 x 0.27 m 21 kg - With instructions in English
CZ-54-MR	Same as CZ-54-R With instructions in English/Arabic
CZ-55-R	Same as CZ-54-R except use tension: 36 kV
CZ-55-MR	Same as CZ-55-R With instructions in English/Arabic - 36kV



# Lines, substations and installations

Low voltage a.c./d.c.

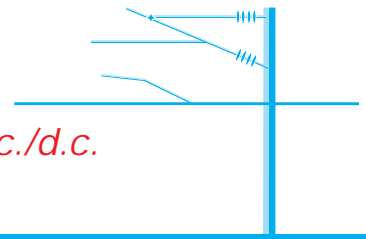

## VOLTAGE DETECTORS

### Voltage multi-tester DETEX™ 911-EX

The DETEX 911-EX has been designed in accordance with IEC 61243-3 and EN 50110-1 standards.

The DETEX 911-EX is a voltage detector which checks the absence of voltage (a.c. or d.c.) and a multimeter.

It enables you to: check the voltage levels from 6 to 600 volts; check the continuity of a disconnected electric circuit; find phase or neutral (by single pole method) determine polarities. It is equipped with 2 test probes and an integrated correct operation test.

Features: Field of use: from 6 to 690 V =/~

Frequency: 50/60 Hz +/- 10%

Operating Temperature: -10°C / +55°C

Protection level: IP54 / IK06

Double insulation class II.



MS-911-EX

Delivered with power supply  
Weight: 0.370 kg

### Voltage multi-tester DETEX™ 911/BR

The DETEX 911/BR has been designed in accordance with IEC 61243-3 and EN 50110-1 standards.

The DETEX 911/BR is a voltage detector which checks the absence of voltage (a.c. or d.c.) and a multimeter.

It enables you to: check the voltage levels from 24 to 900 volts; check the continuity of a disconnected electric circuit; find phase or neutral (by single pole method) determine polarities. It is equipped with IP2X safety test probes and an integrated correct operation test.

Features: Field of use: from 24 to 900 V =/~

Frequency: 50/60 Hz +/- 10%

Operating Temperature: -10°C / +55°C

Protection level: IP54 / IK06

Double insulation class II.

MS-911/BR

Delivered with power supply  
Weight: 0.370 kg

### Voltage multi-tester with phase rotation DETEX™ 911/2

The DETEX 911/2 has been designed in compliance with IEC/CENELEC standard 61243-3 in response to the requirements of European standard EN 50110-1.

The device is a voltage detector which checks the absence of voltage (AC and DC) and a multi-tester.

It enables to:

- check the voltage levels 12 to 400 Volts;
- check the continuity of disconnected electric circuit;
- find phase or neutral (by single pole method);
- Control the phase rotation;
- Determine polarities.

It is equipped with IP2X safety test probes.

#### Technical features

Field of use: From 12 to 400 V A.C and D.C

Frequency: 50/60 Hz

Operating temperature: -10/+55°C

Storage temperature: -25/+55°C

Protection level: IP54

Double insulation Class II



MS-911/2

Delivered with power supply  
Weight: 0.370 kg

#### Accessories for MS-911 serie

M-87369

Storage Bag





# Lines, substations and installations

Low voltage a.c./d.c.

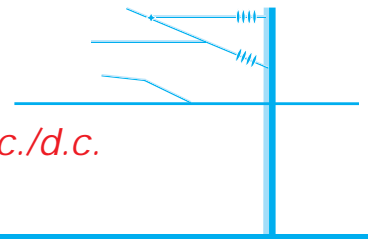

## CONSUMERS UNITS SYSTEM, JUMPER CABLES

### Short-circuiting system for underground networks

$I_{cc} = 4kA / 1 s.$

Short-circuiting system for low voltage consumer unit especially designed for underground networks including:

- copper braids with 4 or 5 insulated conductors 25 mm<sup>2</sup> H07RNF type interconnected by an overmolded insulation brass contact piece.
- revolving extra small size contact clamps
- fork type adapters to fit fixed jaws in a fuse box or cabinet.
- Threaded adapters M6, M8, M10, M12 to fit threaded stems.
- Insulated spanner to tighten the extra small size clamps and equipped with a neon detector to verify voltage absence.
- insulating box spanner (10 / 17) to install threaded adapters.
- insulated eye spanner (13 / 14 / 17) for tightening of terminal pads.



MC-244/1	System with 4 cables
MC-245/1	System with 5 cables

### Short-circuiting and earthing systems

Earthing clamp for connection to circular diameter and attached by stick tightening.

The connecting set formed by extra multi strand copper cables 16mm $\leq$  with silicon sheath according IEC61230.

- Materials:
  - Body: Aluminium.
  - Screw: stainless steel.
  - Lg: 3 x 0.75 m / 1 x 2 m.

Connection for cables fitted with screw terminal diam.8 mm. End fitting: "C" type.

- One equipment includes:
  - 2 set of 4 clamps with cables,
  - 1 stick,
  - Notice and carrying bag.



Reference	ICC	IEC	Clamping capacities
ZEMCT 32 SNCF PS	4kA/1s	61230	diam. 6 to 30mm

### Jumper cable with insulated jumper clamps

2 clamps MC-120.

Spring tightening. Connector for 8 mm cable Ø.

Tightening capacity: 12 mm (diameter - flat).

Rated insulation: 1 500 V. Rating 5 (kA/1 s).

Continuous rating 75 A.

1 insulated cable 25 mm<sup>2</sup> section.



Reference	Cable length (m)	Weight (kg)
MC-120/15	1.50	0.850
MC-120/50	5.00	1.950

### Bayonet earthing connection

Earthing connection to screwed on earthing bar or on earthing platform on one side and to connect on a lug equipped with cable and clamp on the other side.

- Materials

-Body: brass

Connection for cables fitted with screw terminal diam.12mm



Reference	Materials
ZEMCT NAC 01	Body: brass



# Lines, substations and installations

Medium voltage a.c.

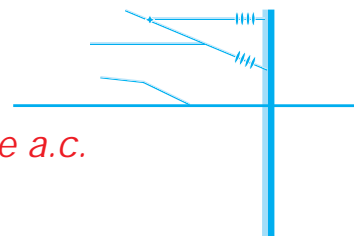

## VOLTAGE DETECTORS

### Electronic voltage detectors with contact electrode extension

**Voltage presence is indicated by:** IEC-61243-1 ⚠

- red flashing LED'S (very bright - visible at more than 50 m in direct lighting)
- powerful rated audible signal > 60 dB (A)/2 m

**Check of working order:**

- by pressing the TEST button:
  - red LED flashes on
  - sound signal is activated
- when TEST button is released:
  - timed green LED lights up. While remaining on, this LED indicates the good working order of the detector. It lights off as soon as the red LED lights up in case of a voltage presence.

This checking validates the good working order of the detector.

**Characteristics**

Detectors are adjusted, tested and controlled one by one. Precise and stable operating threshold. Reduced sensitivity to induced voltages.

Dielectrically tested on substation bars. High environmental resistance (impacts, vibrations, moisture).

Temperature conditions: class N (IEC-61243-1 standard). storage and operation: -25 / +55 °C

Robust housing.

Power supply: one 9-V alkaline battery type 6 LR 61.

The voltage detector is always ready for use, since it is on continuous monitoring conditions with almost no battery consumption. Under normal use conditions the batteries last more than a year.

Contact electrode extension fitted to the housing by screwing.

Delivered complete in a bag with insulating stick.

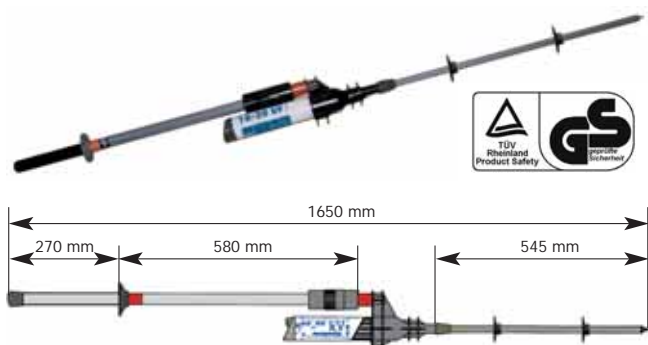

Reference	Voltage (kV)	Frequency (Hz)	LG (mm)	LH (mm)	LI (mm)	LA (mm)	Weight (Kg)
CC-575-5/15-BS	5-15	50	1.485	200	525	650	1.70
CC-575-10/20-BS	10-20	50	1.485	200	525	650	1.70
CC-575-10/30-BS	10-30	50	1.645	200	525	810	1.80
CC-578-15	15	16 2/3	1.650	970	580	545	1.95
CC-577-10/17.5	10-17.5	50	1.790	400	525	700	1.95

### Voltage tester for M.V. separable connectors

Check the absence of voltage on the capacitive terminals of plug-in M.V. bushings.

Sensor in the form of a bent finger enabling removal and reinstallation of the terminal insulating cover.

Signal via beeping and bright red flashing of electro-luminescent diodes.

Built-in function test via the "TEST" button which covers the entire device.

Permanent stand-by state.

Power supply: four 1.5 V, R-6 batteries.

Mounting on insulating stick via a universal end.



CC-151-K	Tester in rigid case with batteries 70 x 100 x 165 mm - 0.70 kg
CC-45-K	Special 45 kV insulating stick L = 1.25 m - 0.6 kg

### Voltage detector

For indoor use

Built-in device for checking operation of the led's indicator via a piezo-electric generator.

High-brightness led's indicator.

Sturdy thermo-plastic moulded case.

Pivoting contact electrode enabling wire contact at any angle.

Telescopic insulating stick.

Operating voltage (kV)	Length (m)		Weight (kg)
	extended	folded	
5-40	1.26	0.85	0.95

CL-4-41/2	Delivered in a waterproof fabric case with strap - Weight: 0.95 kg
-----------	--------------------------------------------------------------------





# Lines, substations and installations

Medium voltage a.c.

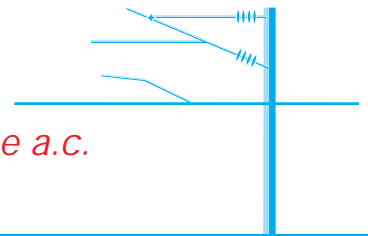

## VOLTAGE DETECTORS

### IEC electronic Voltage Detectors, "Compact serie" for indoor and outdoor use

Ultimate technology of voltage detector "Head Capacitive Technology"

IEC-61243-1 CE

#### Compact and light

It offers:

- a wide range
- a universal application (50/60 Hz)

#### Voltage presence is indicated by:

- red flashing LED (very bright -visible at more than 20 m in direct lighting)
- powerful rated audible signal > 60 dB(A)/2 m

#### Operating check:

By pressing the TEST button, correct operation is indicated as follows:

- a red LED flashes on
- sound signal

(during and after this test, the timed green LED lights up. While remaining on, it indicates the good working order of the detector)

#### Characteristics:

- Detectors have unitary adjustment and are checked by routine test
- Dielectrically tested on substation bars (bridging test)
- Precise and stable operating threshold
- Reduced sensitivity to induced voltages
- Reduced sensitivity to interference field
- High environmental resistance (impacts, vibrations, moisture)

Use from 50 to 60 Hz

Temperature conditions: class N (IEC-61243-1 standard).

Storage and operation: -25 / +55 °C

Robust housing.

Power supply: 1 x 9 V alkaline battery type 6 LR 61

Contact electrodes fitted to the housing by screwing and are easily interchangeable.

#### End fittings:

C = hexagonal 12 mm, for hexagonal end-fitting sticks.

K = universal, for universal end-fitting sticks.

Weight of the detector: 420 g

Size of the detector: Ø 59 x 270 mm

Packaging: unit supplied complete in a case with batteries and contact electrodes.

Total weight: 1.1 kg

Total size: 340 x 275 x 83 mm

\* Specify type of mounting when ordering: C or K.

#### Recommended stick:

CE-4-21. See page 48.



CC-875-10/36\*



C

K

Frequency 50/60 Hz	
Reference	Operating voltage (KV)
CC-875-5,5/20	5.5-20
CC-875-10/36*	10-36
CC-875-11/33*	11-33
CC-875-25	25 with hook

\* Specify type of mounting when ordering: C or K.

For other voltages, please consult us.



# Lines, substations and installations

Medium voltage d.c.

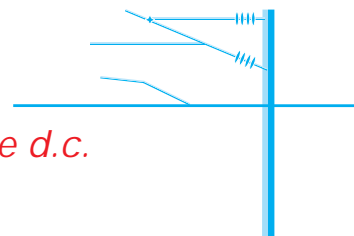

## VOLTAGE DETECTORS

### d.c. voltage detector acoustic and optical signal

Two-pole voltage detector for the presence of voltage equipped with a flexible cable terminated by a contact clamp.

- Presence of voltage is indicated by:
  - illumination of 6 red LEDs
  - an audible signal (60 dbA/2 m)

• Correct operation check:

Correct operation of the equipment is verified:

- by pressing the test button which causes:

- illumination of the 6 red LEDs
- activation of the audible signal

and

- by releasing the test button which causes:
  - temporary illumination of 6 green LEDs

The correct operation check consists in a built-in device. It checks all of the detector's functions.

• Characteristics:

No previous voltage adjustment required

Routine operations in factory to adjust and test the equipment

- Power supply: 1 x 9 V alkaline battery, type 6 LR 61
- Supplied in plastic case
- Weight: 1.5 kg
- Cable length: 8 m
- Clamping capacity: 5-33 mm



Reference	Field of use	Fitting	Contact-piece	Total length (mm)
ZVATDC 2000 HS	600-2000	H	ANTP	415
ZVATDC 2000 RS	600-2000	R	ANTP	485
ZVATDC 3000 HS	750-3000	H	ANTP	415
ZVATDC 3000 RS	750-3000	R	ANTP	485
ZVATDC 4000 HS	1500-4000	H	ANTP	415
ZVATDC 4000 RS	1500-4000	R	ANTP	485

### d.c. voltage detector acoustic and optical signal

Two-pole voltage detector for the presence of voltage equipped with two insulating sticks.

- Presence of voltage is indicated by:
  - illumination of 6 red LEDs
  - an audible signal (60 dbA/2 m)

• Correct operation check:

Correct operation of the equipment is verified:

- by pressing the test button which causes:

- illumination of the 6 red LEDs
- activation of the audible signal

and

- by releasing the test button which causes:
  - temporary illumination of 6 green LEDs

The correct operation check consists in a built-in device. It checks all of the detector's functions.

• Characteristics:

No previous voltage adjustment required

Routine operations in factory to adjust and test the equipment

- Power supply: 1 x 9 V alkaline battery, type 6 LR 61
- Supplied in plastic case
- Weight: 6 kg
- Cable length: 2 m



Reference	Field of use	Contact-piece	Total length (mm)
ZVATDC 3000 PS	750-3000	ANTP	910

### Contact-pieces



Reference	Dimensions (mm)	Reference	Dimensions (mm)
ZANTC M8	Ø 70	ZANTV M8	-
ZANTCT M8	Ø 70	ZANTD M8	-
ZANTP M8	-		



# Lines, substations and installations

Medium voltage a.c./d.c.

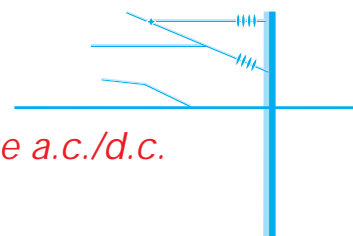

## VOLTAGE DETECTORS

### Two-pole phase comparator for indoor and outdoor use (a.c./d.c.)

Precise indications provided by the galvanometer needle; dials are calibrated according to voltage. Assessment of the voltage value on testers/measurers. Complete function testing built-in, with TEST push-button (battery supplied). Consists of two elements connected by a high-insulation lead. Removable handles. Device delivered in metal case. 140 x 250 x 850 mm - 7.5 kg.



Reference	Voltage (kV)	Dial scale (kV)	Observations
			<b>Phase tester</b>
CL-5-33-GB	11-33	11-33 A. C/D. C	Straight & angled antennae
CL-5-36	5-36	5-10-15-20-25-30-36 A. C/D. C	Straight antennae
			<b>Tester-measurer</b>
CL-5-03	0.75-3	0.75-1-1.25-1.5-3 A. C/D. C	Straight antennae

### Single pole phase comparator for indoor and outdoor use (a.c.)

Frequency and voltage phase memory. Integrated TEST push-button. Orange LED = indication that frequency and voltage are in memory. Green LED = phasing indication. Red LED = non-phasing indication. Powered by a LF 22 9 V battery. Delivered in carrying case.



Reference	Voltage (kV)	Length of antenna (m)
CL-7-06/18*	6-18	0.85
CL-7-10/30*	10-30	0.85
CL-7-10/30-1*	10-30	1.15
CL-7-12/36*	12-36	1.20

\* Please specify type C or K when ordering.

For other voltages, please contact us.

### d.c. bipolar voltage detector 0.6 to 2 kV

#### Operation

Two-pole voltage detector for the presence of voltage between the catenary and the rail

- Presence of voltage is indicated by:
  - illumination of 6 red LEDs
  - an audible signal (60 dbA/2 m)
- Correct operation check: Correct operation of the equipment is verified:
  - by pressing the test button which causes:
    - illumination of the 6 red LEDs
    - activation of the audible signal

and

- by releasing the test button which causes:
  - temporary illumination of 6 green LEDs

The correct operation check consists in a built-in device. It checks all of the detector's functions.

Stand-by state

No previous voltage adjustment required

Routine operations in factory to adjust and test the equipment

Detector fixed to stick, attachment to rail by metal spring-contacts

Power supply: 1 x 9V alkaline battery, type 6 LR 61

Stick included in pack: CC-1515-101

Supplied in carrying case: CM-303.



Reference	Operating voltage (kV)	Weight (kg)
CC-1515-100	0.6 to 2 d.c.	5.2

### Telescopic insulating stick



Telescopic insulating stick, 3 elements, fully folded/extended: 1.65 x 3.95 m, including:

- Regulation piece of intermediary position.

Reference		Voltage (kV)
CC-1515-101	Stick	0.6 - 1.5
CC-1515-102	Antenna	0.6 - 1.5

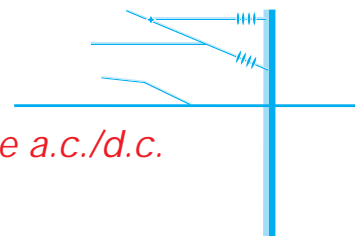

## SHORT-CIRCUITING AND EARTHING SYSTEMS

### Clamps for MV installations and substations

#### Earth cable connection

With a crimped lug (12 mm Ø hole).

#### Material

Aluminium alloy except MT-814, MT-1911 and MT-1921: copper-aluminium bronze.



MT-812-C

MT-817-C

MT-813-C

MT-814/2  
MT-814/3



MT-815-C



MT-815-S1



MT-1911-E  
MT-1921-E



MT-1911-S1  
MT-1921-S1



Reference	Weight (kg)	Dimensions (mm)	Conductors (mm)	Test current (kA/1s)
MT-812-C	0.320	35 x 79 x 143	● Ø 5-16 ■ 0-16	21
MT-813-C	0.330	35 x 79 x 169	■ 40 x 16	21
MT-814/2-C	0.660	85 x 56 x 192	● Ø 5-28	14.5
MT-817-C	0.330	30 x 90 x 140	● Ø 5-16 ■ 40 x 16	21
MT-814/3-C	0.620	85 x 56 x 195	● Ø 18-33	14.5
MT-815-C MT-815-E MT-815-S MT-815-S1	0.650	44 x 100 x 180	● 5-35 ■ 16-40 ■ 5-40	30
MT-1911-E MT-1911-S1	0.580	For permanent fixed point Ø 20 mm and round conductors Ø 8 to 18 mm		20
MT-1921-E MT-1921-S1	0.69	For permanent fixed point Ø 25 mm and round conductors Ø 10 to 25 mm		30

### Earth clamps

Copper aluminium bronze earth clamps.



MT-840/1



MT-841



MT-1911  
MT-1921

#### For bare conductors

Reference	Weight (kg)	Dimensions (mm)	Conductors (mm)	Test current (kA/1s)
MT-840/1	0.48	Connector: TO-08 - 35 mm <sup>2</sup>	● Ø 6-25 ■ 0-25	20
MT-841	0.48	Connector: ≤ 50 mm <sup>2</sup>	● Ø 6-25 ■ 0-30	30

#### For fixed point

Reference	Weight (kg)	Connection conductors (mm)	Test current (kA/1s)
MT-1911	0.58	Spheric fixed points MT-2951 Ø 20 mm Round conductors Ø 8 to 18 mm	20
MT-1921	0.69	Spheric fixed points MT-3951 Ø 25 mm Round conductors Ø 10 to 25 mm	30

### Fixed points

IEC-61230

MT-2951  
MT-3951  
MT-3952



MT-2951/1  
MT-2951/2  
MT-3951/1  
MT-3952/1

#### For flat conductors

Reference	Sphere dim. (mm)	Weight (g)	Fixing	Test current (kA/1s)
MT-2951	Ø 20	130	Thread: M 12	20
MT-2951/1	Ø 20	180	Bolt: M 12 - L = 35 mm	20
MT-2951/2	Ø 20	200	Bolt: M 12 - L = 45 mm	20
MT-3951	Ø 25	240	Thread: M 12	30
MT-3952	Ø 25	240	Thread: M 16	30
MT-3951/1	Ø 25	300	Bolt: M 12 - L = 45 mm	30
MT-3952/1	Ø 25	350	Bolt: M 16 - L = 45 mm	30

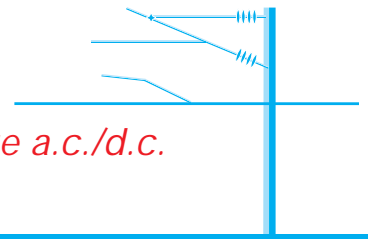

## SHORT-CIRCUITING AND EARTHING SYSTEMS

### IEC short-circuiting and earthing systems for MV substations

These equipment are intended for connection: to permanent fixed points or to bare conductors. They consist of 3 contact clamps. 1 short-circuit earthing connection set consisting of 3 extra-flexible copper cables with silicone sheath, L = 1.5 m each. 1 trifurcation connector earthed by an extra-flexible copper cable with silicone sheath, L = 2.5 m. 1 earthing clamp. 1 plastic case (M-78665).

IEC-61230

#### Installation on permanent fixed points

#### Installation on bare conductors



Reference	MT-1910	MT-1920
Icc (kA/1 s)	20	30
Installation on fixed points	Ø 20 mm MT-2951 range	Ø 25 mm MT-3951 range
Composition	3 clamps MT-1911-E 1 MT-1911	3 clamps MT-1921-E 1 MT-1921
Connection set	3 cables 95 mm <sup>2</sup> 1 earth cable 35 mm <sup>2</sup>	3 cables 150 mm <sup>2</sup> 1 earth cable 50 mm <sup>2</sup>
Sticks**	CF-5-40-E	CF-5-40-E

\*\* Stick to be ordered separately.

For earthing systems to your own specifications, please see page 69.

Reference	MT-5805	MT-9801
Icc (kA/1 s)	20	10
Conductors (mm)	● Ø 5-35 ┃ 16-40 ┃ 5-40	● Ø 5-16 ┃ 0-16 ┃ 40-16 ● Ø 5-28
Composition	3 clamps MT-815-C 1 earth clamp MT-840/1	3 clamps MT-817-C 3 clamps MT-814/2 1 earth clamp MT-840/1
Connection set	3 cables 95 mm <sup>2</sup> 1 earth cable 35 mm <sup>2</sup>	3 cables 50 mm <sup>2</sup> 1 earth cable 25 mm <sup>2</sup>
Sticks**	CE-4-21-C	CE-4-21-C

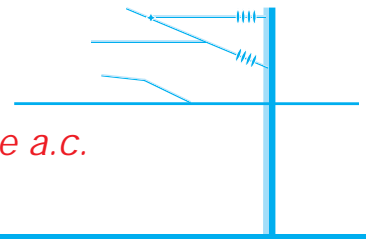

## SHORT-CIRCUITING AND EARTHING SYSTEMS

### Short-circuiting and earthing systems for switchgear and metalclad switchgear



#### Short-circuiting and earthing systems for 250 A separable connectors

- Rating = 12.5 kA/1 s.  
 Equipment consisting of:  
 3 terminals, each fitted with a "handarff device" for locking.  
 1 terminal connecting kit, with double-crimped connectors  
 • 3 copper cables, 70 mm<sup>2</sup> section, length ~ 0.70 m  
 • 1 copper cable, section 35 mm<sup>2</sup>, length ~ 2 m  
 • 1 earthing clamp MT-840/1  
 3 padlocks AL-230-S.



MT-8612

Delivered in metal box  
 620 x 195 x 150 mm - Weight: 7.6 kg

#### Stand by devices

- Allows the supply under voltage  
 Equipment composition:  
 3 insulating "EPDM" interfaces  
 3 padlocks.



MT-8601

MT-8602

#### For 250 A separable connectors

MT-8601 Delivered with 3 padlocks AL-230 in metal case  
 315 x 160 x 150 mm - Weight: 4 kg

#### For 400 A separable connectors

MT-8602 Delivered with 3 padlocks AL-230 in metal case  
 315 x 160 x 150 mm - Weight: 5.8 kg

#### Short-circuiting and earthing systems for 400 A separable connectors

- Rating = 12.5 kA/1 s  
 Equipment consisting of:  
 3 terminals, each fitted with a bolted stirrup for locking.  
 1 terminal connecting kit, with double-crimped connectors  
 • 3 copper cables, 70 mm<sup>2</sup> section, length ~ 0.40 m  
 • 1 copper cable, section 35 mm<sup>2</sup>, length ~ 2 m  
 • 1 earthing clamp MT-840/1  
 3 padlocks AL-230-S.



MT-8614

Delivered in metal box  
 480 x 340 x 195 mm Weight: 13.5 kg



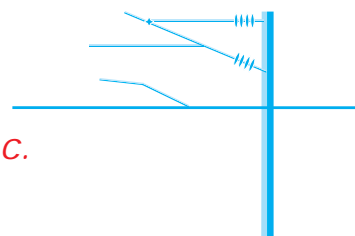

## VOLTAGE DETECTORS

### 63 to 550 kV electronic voltage detectors for indoor and outdoor use

Designed to give users maximum safety, the DETEX detectors of the CC-245 Series are the result of the most modern developments in electronic research. They offer a number of important properties and advantages.

#### Double signalling

Voltage presence indicated at the same time by:

- 4 extremely bright red flashing electro-luminescent diodes (visible at more than 50 meters even in direct lighting),
- a powerful rated acoustic signal (60 dB/2 m).

#### Checking

Satisfactory operation of the unit is indicated:

- When pressing the test button, by:
  - the red diodes flashing,
  - the acoustic signal sounding.
- When releasing the TEST button, by:
  - timed green up diodes lighting.

As long as they light, the unit continues its self-testing and the detector is fully operational.

#### High specifications

- Detectors are adjusted, tested and controlled one by one.
- Remarkably resistant to impacts, vibrations, extreme temperatures, humidity and sudden changes in the atmosphere (condensation, freezing).
- Precise and stable operating threshold. Insensitivity to induced voltages by limiting the operating voltage range.
- Robust housing made from polycarbonate with high mechanical properties and dielectric strength.
- The contact electrodes are simply screwed to the housing and are therefore easily interchangeable.

#### Power supply

- One 9 V battery type 6 LR 61.

#### End fittings:

- "C" for hexagonal sticks.
- "K" for universal sticks.

#### Weight

500 g (with battery).

#### Packaging

Units supplied complete with battery and electrode in a rigid synthetic case with handle.

- **Recommended sticks:** CM-46... serie. See pages 15/43.



CC-245-63/90-C



CC-245-150/420-K

Reference	Operating voltage (Ph/Ph-kV)	Contact electrode Ø (mm)	Body colour	Freq. (Hz)
FRENCH STANDARD NETWORKS				
CC-245-63/90...*	63-90	120	Yellow	50
CC-245-225/420...*	225-420	200	Red	50
BRITISH STANDARD NETWORKS				
CC-245-66/132-K	66-132	200	Red	50
OTHER MODELS				
CC-248-110-K	110	120	Red	16 2/3
CC-245-63/150-K	63-150	120	Red	50
CC-245-90/225-K	90-225	120	Red	50
CC-245-150/420-K	150-420	200	Red	50
CC-245-225/550-K	225-550	200	Red	50

\* Please specify type of mounting when ordering: C or K.

For other voltages, or 60 Hz Frequency detectors (CC-246 Serie) please consult us.

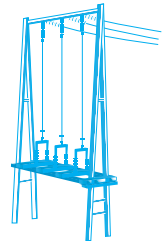

### HV and EHV clamps manoeuvrable by insulating stick

Body in aluminium alloy with trapezoidal threaded screw. Interposed elastic washers in the clamping system improve efficiency and insure a higher withstand in case of electrodynamic shock. Manoeuvring by CM-6 insulated stick of appropriate length and characteristics.



MT-731



MT-732



MT-734



MT-735



MT-737-H



MT-732-A  
MT-731-A

MT-732-B  
MT-731-B

MT-732-E  
MT-731-E

MT-732-H  
MT-731-H



MT-734  
MT-735

MT-734-A  
MT-735-B

MT-734-B  
MT-735-B

MT-734-E  
MT-735-E

MT-734-H  
MT-735-H

Reference	Clamping capacity (Ø mm)	Rating insulation (kA/1 s)	I asymmetrical (A)	Copper connection			Weight (Kg)	Dimensions (mm) h x L x thickness
				Copper cables (mm² max.)	Ø range (mm)	Stud or hole		
MT-731*	5-60	40	92	150	45	M 12	1.45	200 x 200 x 50
MT-732*	40-120	40	93	150	45	M 12	1.45	200 x 200 x 50
MT-734*	5-40	40	92	150	45	M 12	0.8	145 x 125 x 52
MT-735*	15-60	40	92	150	58	M 12	0.8	195 x 135 x 45
MT-737-H	20-120	40				M 12	1.35	340 x 200 x 55

\* Add type of connection A - B - E - H.

Attachment of MT-734/MT-735 clamps with MT-717-3-B hook.

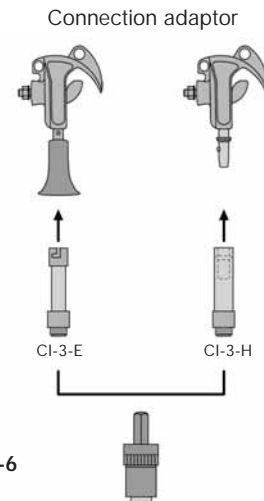
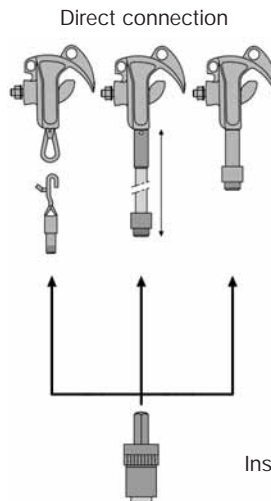

Insulated sticks CM-6 see page 44.

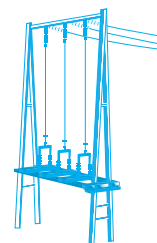

## INSULATING STICKS, ACCESSORIES

### Insulating sticks for short-circuiting and earthing systems

Made of IEC-60855 orange foam filled tube, these Ø 39 mm dia. elements are assembled using a new safety bayonet system connector in aluminium alloy. They allow construction of a large variety of custom made sticks that meet the most varied conditions of application. Calibrated lengths of 1 to 3 meters (with fraction of 0.50 m) permit a huge number of applications.

#### CM4000

Reference	Complete stick length (m) <sup>*</sup>	Complete stick length (m) <sup>**</sup>	Insulating length (m)	Weight (kg)
<b>Basic elements</b>				
CM-4610	1.13		0.08	1.35
CM-4615	1.63		0.33	1.80
CM-4620	2.13		0.33	2.80
CM-4625	2.63		0.83	3.30
<b>Intermediate element</b>				
CM-4610-I	1.165		0.8	1.30
CM-4615-I	1.665		1.3	1.70
CM-4620-I	2.165		1.8	2.60
CM-4625-I	2.665		2.3	3.10
<b>Terminal elements</b>				
CM-4610-*	1.115	1.21	0.78	1.00
CM-4615-*	1.615	1.71	1.28	1.40
CM-4620-*	2.115	2.21	1.78	2.20
CM-4625-*	2.615	2.71	2.28	2.70
<b>Fixed length sticks</b>				
CM-4115-*	1.575	1.675	0.82	1.35
CM-4120-*	2.075	2.175	1.07	1.80
CM-4125-*	2.575	2.675	1.32	2.80
CM-4130-*	3.075	3.175	1.82	3.30
<b>Intermediate elements with rain skirts</b>				
CM-4600-J	0.36			0.95

\* Add end piece C, K, E.

• With the smallest end fitting.

•• With the biggest end fitting.

This range thus allows a stick-length limitation in case of space requirements and carrying capabilities.

IEC-60855

For common applications a serie of complete sets including 2 or 3 elements are made to give simple solutions for working distance from 2 to 6 meters.



New safety bayonet system

Hand guard

Handle grip

Manoeuvring and lifting eyelet

CM-4600-J

### Carrying and storage stick case

Case especially designed for Ø 39 mm new range sticks. Carrying capacity: 3 elements.



CM-3000 480 x 330 x 120 mm - Weight: 1.2 kg

### Set of sticks

Complete sets of sticks for standard applications.

IEC-60855

Reference	Working distance (m)	Composition
CM-4220*	2	2 elements: CM-4610 + CM-4610-*
CM-4230*	3	2 elements: CM-4615 + CM-4615-*
CM-4240*	4	2 elements: CM-4620 + CM-4620-*
CM-4330*	3	3 elements: CM-4610 + CM-4610-I + CM-4610-*
CM-4345*	4.5	3 elements: CM-4615 + CM-4615-I + CM-4615-*
CM-4360*	6	3 elements: CM-4620 + CM-4620-I + CM-4620-*

\* Add end piece C, K, E.

For cables < 95 mm<sup>2</sup> CM-4000 serie is recommended.

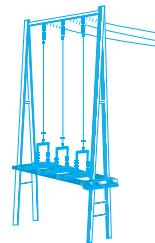

## INSULATING STICKS, ACCESSORIES

### Insulating sticks for short-circuiting and earthing systems

- 46 mm dia. single type elements, yellow colour, with superior characteristics, they are connected between them without any prior order of assembly.
- These elements allow "long length" assemblies which can support short-circuit systems with large cross-section cables.
- Shockproof guard and pole end cap.



Reference	Length (mm)	Weight (Kg)
CM-6-15	1.5	2.40
CM-6-20	2.0	3.20
CM-6-25	2.5	4.00
CM-6-30	3.0	4.80

For cables  $\geq 95 \text{ mm}^2$  CM-6 series is recommended.

### Connection adaptors for insulating sticks

- For earthing systems

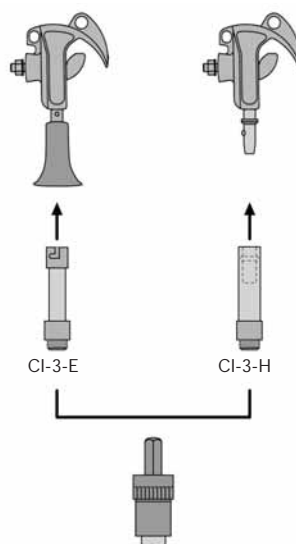

- For voltage detectors

Accessories	E	C
Connection adaptors	CI-7-E	CI-6-C
Sticks	K	K

### Earthing kit support

- Welded steel assembly with galvanization surface treatment.
- Writing zone available.



MT-895 230 x 230 x 150 mm - Weight: 0.9 Kg

### Short-circuiting and earthing systems carrying bags

Strong water proof canvas. Reinforced bottom.

M-87-53	380 x 250 - Height: 400 mm - Weight: 2 kg
M-87-153	380 x 250 - Height: 600 mm - Weight: 2.5 kg
M-87-295	550 x 300 x 300 mm - Weight: 2 kg



M-87-295



M-87-53

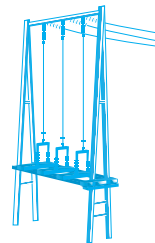

## EXTENDED CLAMPS FOR HIGH LEVEL BUSBAR IN HV SUBSTATIONS

### Extended clamps for high level busbar in HV substations

Assembly includes:

- One aluminium alloy electrical tube (Icc = 25 kA / 1 s), on top of which is an aluminium alloy contact clamp and on bottom an access point on which will be installed the grounding clamp.
- In the inside of the previous tube is a second one allowing the clamp to be tightened over busbar conductor or pipe by means on the bottom side of a rod connector type FL so that the assembly can be installed with an insulating stick ref. ZPL9R FL.

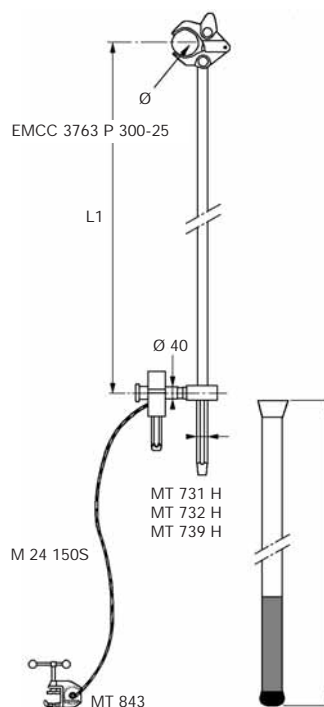
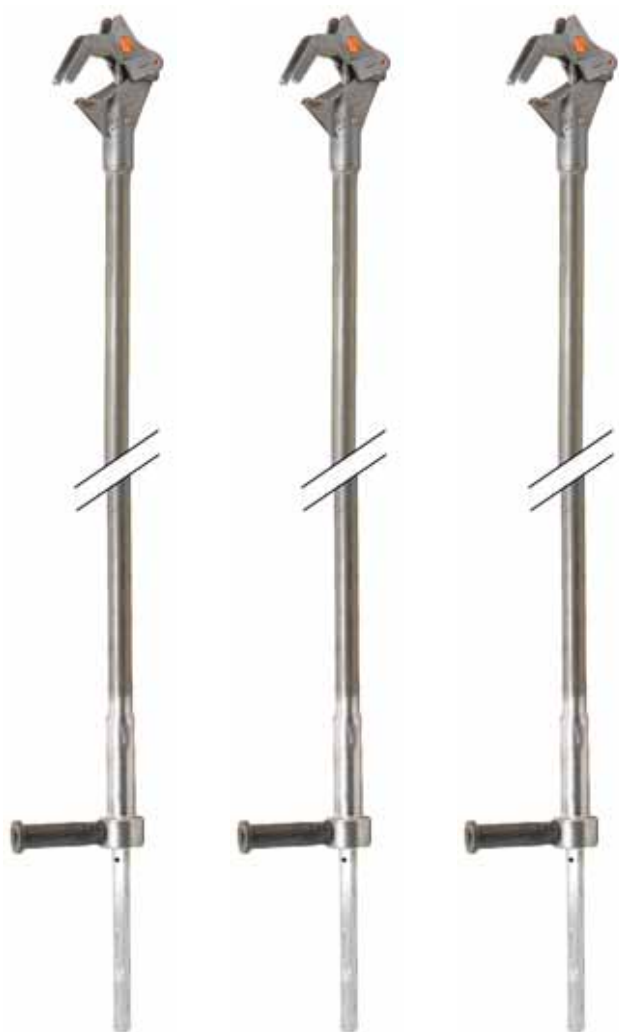

### Switch clamps

- ZPL9R FL: insulating sticks  $\varnothing$  47 mm of yellow colour, length 3 or 4 m, equipped on one end with a hex female connector 26 mm on flat and on the other side with a rubber cap handle to ensure a firm grip.



Reference	L 2 (m)
ZPL9R 130 FL	3.00

Reference	L 1 (m)	Ø (mm)	Icc (kA / 1 s)
ZEMCC 3763 P 300-25	3.00	40 - 120	25



# Lines, substations and installations

High voltage a.c./d.c.

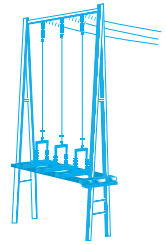

## CABLES AND EARTH CLAMPS

### Copper cables

Transparent silicon sheath according to IEC-61230 Resistant to temperature variations (-40 °C to +70 °C) with double IEC triangle marked on cable section.



IEC-61230	Rating (kA/1 s)	Cable Weight (kg/m)	Cable Ø (mm)	Section (mm <sup>2</sup> )
M-24-50-S	12	0.545	10	50
M-24-70-S	16	0.768	12	70
M-24-95-S	20	1.000	14	95
M-24-120-S	30	1.280	17	120
M-24-150-S	36	1.630	19	150

For leads with double-crimped lugs, please consult us.

To indicate your short-circuiting and earthing system, use warning earth flag and for definition of your working zone: see page 10.

Copper cables only:  
Heating curves (Gut & Grundberg method)

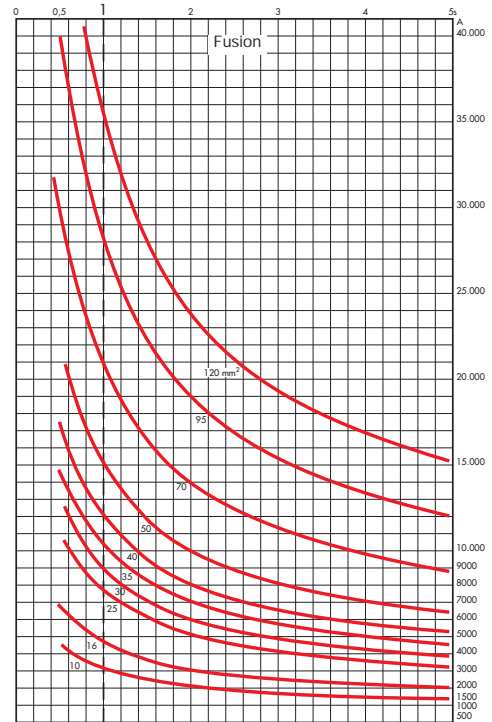

### Earth clamps

Copper aluminium bronze earth clamps.



Reference	Rating insulation	Dimension (mm) Weight (kg)	Connection	Clamping capacity (mm)
MT-843	40 kA/1 s	45 x 106 x 165 0.95	Hole: Ø 13 mm	● Ø 6-35 — 0-35
MT-847	30 kA/0.5 s	45 x 106 x 170 1.00	Hole: Ø 13 mm	— 0-25
MT-852	40 kA/1 s	70 x 125 x 155 1.40	Hole: Ø 13 mm	Fixed points
MT-853	40 kA/1 s	65 x 130 x 135 1.00	Hole: Ø 13 mm	Fixed points

Copper cables only:  
Heating curves - 300 °C

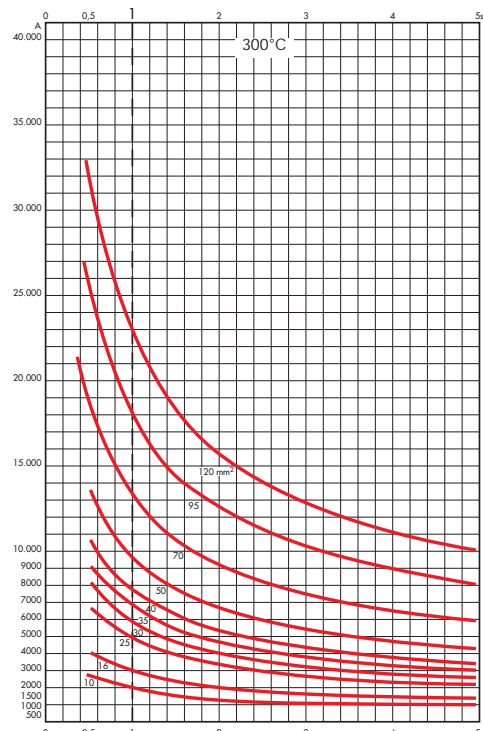



# Lines, substations and installations

High voltage a.c./d.c.

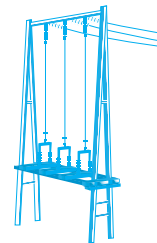

## FIXED POINTS, ACCESS POINTS

### Adjustable fixed points

For large vertical or oblique heavy duty conductors.



Reference	Rating insulation (kA/1 s)	Weight (kg)	Dimensions L x W x T (mm)	Conductors Type	Conductors Ø (mm)	Description
MT-790	30	1.400	255 x 105 x 50	Copper	12-60	arm Ø 18 mm
MT-792	30	0.855	270 x 105 x 60	Aluminium	12-60	arm Ø 20 mm
MT-797	20	1.200	240 x 170 x 60	Aluminium	60-120	arm Ø 20 mm

### Access points

All our saddles are delivered with copper-aluminium bolt, screw, nut and lock nut. On request, earthing clamps can be supplied with bi-metallic plate and washer.



ZSTA1



ZSTDA1

#### Single access points (single or double)

Reference	Cable area (mm <sup>2</sup> )	HR Bronze bolt	Short circuit value	Base A to B
ZSTA 1-75	75	12 x 50	20 000 A / 1 s	50 x 30
ZSTDA 1-75	75	12 x 70	20 000 A / 1 s	50 x 30



ZSTN147



ZSTDN75



ZSTA2



ZSTDA2

#### Double access points (single or double)

Reference	Cable area (mm <sup>2</sup> )	HR Bronze bolt	Short circuit value	Base A to B
Single or double				
ZSTA 2-116	75-116	12 x 50	30 000 A / 1 s	50 x 30
ZSTA 2-147	147	14 x 50	40 000 A / 1 s	50 x 30
ZSTA 2-181	181.6	16 x 60	63 000 A / 0.5 s	54 x 31
ZSTDA 2-116	75-116	12 x 70	30 000 A / 1 s	50 x 30
ZSTDA 2-147	147	14 x 70	40 000 A / 1 s	50 x 30
ZSTDA 2-181	181.6	16 x 80	63 000 A / 0.5 s	54 x 31
Double position (type CRTT)				
ZSTA 2-147 DP	75-147	12 x 50	1 cable	
ZSTDA 2-147 DP	75-147	12 x 70	2 cables	
ZSTA 2-116 USI	75	12 x 50	30 000 A / 1 s	50 x 30
ZSTA 2-147 USI	75	14 x 50	40 000 A / 1 s	50 x 30

#### Access points (single or double)

Reference	Cable area (mm <sup>2</sup> )	HR Bronze bolt	Short circuit value	Base A to B
ZSTN 75-116	75-116	12 x 50	30 000 A / 1 s	50 x 30
ZSTN 147	147	14 x 50	40 000 A / 1 s	50 x 30
ZSTN 181	181.6	16 x 50	63 000 A / 0.5 s	54 x 31
ZSTDN 75-116	75-116	12 x 70	30 000 A / 1 s	50 x 30
ZSTDN 147	147	14 x 70	40 000 A / 1 s	50 x 30
ZSTDN 181	181.6	16 x 80	63 000 A / 0.5 s	54 x 31

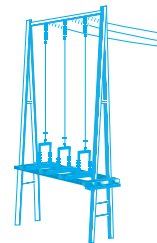

### Telescopic sticks

Telescopic sticks for voltage detectors and earthing systems for use in dry and wet conditions. Telescopic stick contains 2 elements made of polyester/fiberglass foam filled tube, which slide together and are equipped with a push button lock.

IEC-61235

	Rated insulation (kV)	Ø (mm)	Overall length (m)		Weight (kg)
			folded	extended	
CE-4-21*	90	41/32	1.15	2.00	1.50

\* Add end-piece C or K.

### Fixed length stick for use in dry and wet conditions

Manufactured from 36 mm dia. elements, with single 100 dia. skirts, light and rigid, shock resistant.

IEC-61235

	Rated insulation	Ø (mm)	Overall length (m)	Weight (kg)
CE-5-40*	40	36	1.50	1.15

\* Add end-piece C, K or E.

### Extension for insulating sticks

Extension with a male end-piece.

IEC-61235

Reference	Length (m)	Weight (kg)
CM-7-10-A	1.00	1.10

### Insulating clampstick

Reference	Length (m)	Weight (kg)
MG-115/1-S	1.5	2.80

### Wall mounted supports

For sticks and voltage detectors. Plastic. Delivered with wood screws

	Top	Bottom
CI-06-D	Ø 28-30 mm	Ø 36 mm max.
CI-10-D	Ø 28-36 mm	Ø 58 mm max.
CI-12-D	Ø 28-30 mm	Ø 58 mm max.
ZAPSP 08	Ø 46 mm	Ø 46 mm max.







# Personal protective equipment

HEAD AND EYES PROTECTION

50

INSULATING RUBBER GLOVES

51

INSULATING PLATFORMS

53

INSULATING MATS AND BOOTS

54



# Personal protective equipment



## HEAD AND EYES PROTECTION

### ABS helmet

Electrically insulating helmets for use on low voltage installations. Safety industrial helmet, safety helmet for electrical use, especially designed to maximize wearer's comfort. Standard sizes 53 to 63. Leather trim 21 cm along the inside for added comfort. Multiple adjustments for a perfect fit - headband: adjustable in 3 mm increments. Built-in cushion for optimum ventilation. Safety chin strap: fastenings to shell tear resistant. Weight: 0.300 kg.

EN 397  
EN 50365 ⚡  
ANSI 789.1/1986  
20000 V  
CE



MO-182/1-B	White
MO-182/1-R	Red
MO-182/1-J	Yellow

### Polycarbonate helmet

Polycarbonate helmet. Shock and wear resistant, comfortable. Adjustable size from 53 to 63 cm. Weight: 0.465 kg.

EN 397  
CE



MO-183-BL	White, single size, adjustable
MO-183-RL	Red, single size, adjustable

### Helmet with built-in face shield

Panoramic face shield in non-scratch and anti-mist polycarbonate. Protection against electric arcs of short -circuits. Chinstrap (with Velcro fastening) Head fit adjustment by milled wheel.

EN 166/EN 170/EN 397  
CE



MO-185-BL	Single size - Weight: 0.270 kg
M-881622	Spare face shield for MO-185-BL

### Face shield

Face shield adjustable on MO-182 helmet. 100% UV protection. Weight: 0.170 kg. Caution: Do not use for welding operations.

EN 166/EN 170  
CE



MO-184	Single size, adjustable by rubber band
--------	----------------------------------------

### Face shield

Polycarbonate face shield adjustable on the head by milled wheel. Protection against electric arcs of short-circuits. Anti-condensation treatment. Caution: Do not use for welding operations.

EN 166/EN 170  
CE



MO-186	Single size, adjustable
M-881635	Spare face shield for MO-186
M-87384	Bag for face shield and helmet

### Safety glasses

Protection against UV radiation and ejections of solid particles. Grilamid frame in orange Softflex. Anti-scratch, anti-impact and anti-chemical product treatments. Caution: Do not use for welding operations.

EN 166/EN 170  
CE



MO-11000	Clear lenses, delivered in pouch
MO-11001	Tinted lenses, delivered in pouch
MO-11003	Tinted lenses, delivered in pouch

### Overglasses

Polycarbonate overglasses. Protection against UV radiation and ejections of solid particles. Caution: Do not use for welding operations.

EN 166/EN 170  
CE



MO-11010	Clear lenses
MO-11011	Green tinted lenses



# Personal protective equipment



## HEADLAMP, INSULATING RUBBER GLOVES

### Headlamp with adjustable focus

Can be carried either on the head or any type of helmet.  
Lighting control and beam adjustment with one movement, even wearing gloves.  
Adjustable lamp height angle.  
Locking of switch into off position. Sealed against rain.  
Polyamide box, unbreakable polycarbonate glass, shielded cable.  
Incorporated replacement bulb.  
Powered by 4.5 V battery (3 LR 12) or with 3 batteries (LR 6) and adaptor.



MS-118	Headlamp, weight: 0.145 kg
M-95-865	Halogen bulb
M-95-864	Hooks set for helmet

### LED's Headlamps

Can be carried either on the head or any kind of helmet.  
- Lighting by 4 high performance LEDs.  
- 3 lighting levels + 1 flash mode  
- Adjustable lamp height angle.  
- Very light, waterproof IP65.  
- Range: 10 to 15 meters.  
- Powered by 3 batteries LR 03 (AAA).  
- Autonomy: 90 hours.



Fig. 1\*



Fig. 2

\* the support of the lamp is to be glue on the helmet. The lamp is clipped on the support.

MS-122	Delivered with batteries and a carrying bag Weight: 0.09 kg
--------	----------------------------------------------------------------

### Insulating rubber gloves

Insulating rubber gloves conform to international IEC-60903 standard.  
To satisfy the requirements of this standard, they are subjected to dielectrical, mechanical resistance and ageing tests.  
Our gloves are made of latex especially treated to obtain high dielectric characteristics; they are individually tested and delivered in sealed plastic bags.



Lighting by 5 white new generation LEDs  
5 light modes: Red on, Power save, Medium, Bright, Blinking.  
Can be carried either on the head or any type of helmet.  
Powered by 4 batteries LR 06 (AA).  
Range: 30 meters.  
Autonomy: 100 hours.  
IPX6.



MS-127	Delivered with batteries and a carrying bag Weight: 0.226 kg
M-95-864	Hooks set for helmet

Reference	Class	Voltage (V)	Thickness (mm)	Designation	Weight (g)
CG-02 (*)	00	500	1.7	orange composite gloves with mechanical properties	270
CG-05 (*)	00	500	0.5	Latex	90
CG-10 (*)	0	1 000	1.0	Latex	200
CG-12 (*)	00	1 000	2.3	orange composite gloves with mechanical properties	450
CG-15 (*)	1	7 500	1.5	Latex	270
CG-20 (*)	2	17 000	2.3	Latex	450
CG-30 (*)	3	26 500	2.9	Latex	560
CG-40 (**)	4	36 000	3.6	Latex	800

\* References to be completed by size A, B, C or D.

\*\* References to be completed by size C or D.

Correspondence with standard sizes: A = 8, B = 9, C = 10, D = 11.



# Personal protective equipment



## INSULATING RUBBER GLOVES

### Undergloves

Cotton undergloves.  
To be used with insulating rubber gloves.



CE

CG-80 (\*\*)

\*\* H: men / F: women

### Pneumatic glove tester

For compulsory control of gloves before use.  
Checking is done by inflating and immersing in water.



CG-117

140 x 150 x 160 mm - Weight: 0.600 kg

### Rubber gloves storage box with window

To be placed in high voltage stations.  
Insulating material, shock resistant, yellow colour.  
Transparent window (enables to check gloves presence).  
Bottle of talc included.  
Attachment: 4 holes 3.5 mm dia., centre distances 155 x 345 mm.  
U.V. protection window.



CG-35/1

60 x 210 x 460 mm - Weight: 0.730 kg

### Working gloves

Handling leather and cotton gloves. Docker type.

EN 388

CE



CG-96 (\*)

Weight: 0.115 kg

(\*) Add size: A, B, C, D.

### Carrying box

Made from reinforced waterproof fabric for transport of rubber gloves in vehicles and tool boxes.  
Rear loop for belt and snaps.



CG-36

60 x 180 x 400 mm - Weight: 0.120 kg

### Overgloves

Used as outer glove.  
Silicon grain leather, very flexible.  
Large protective cuff in chrome tanned hide.  
Adhesive strap.

CE



CG-98 (\*)

Weight: 0.170 kg

(\*) Add size: A, B, C, D.



# Personal protective equipment

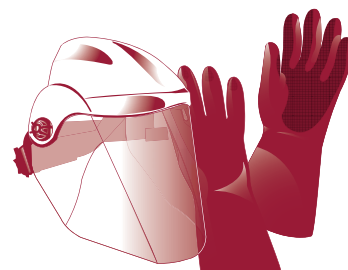

## INSULATING PLATFORMS, RESCUE STICKS

### Insulating platform (indoor models)

Moulded insulating material, one-piece. Top 50 x 50 cm.



Reference	Rated insulation (V)	Height (mm)	Weight (kg)
CT-7-25/1	24 000	220	3.7
CT-7-40/1	40 000	260	3.8

### Insulating platform (indoor model)

Solid plate with moulded insulating material 52 x 52 cm, thickness 40 cm. Feet with rubber tips.



Reference	Rated insulation (V)	Height (mm)	Weight (kg)
CT-7-63	63 000	515	3.35

### Insulating platform (outdoor models)

Solid plate with moulded insulating material 52 x 52 cm, thickness 40 cm. Feet with rubber tips.



Reference	Rated insulation (V)	Number of skirts per foot	Height (mm)	Weight (kg)
CT-9-25	24 000	2	350	6.00
CT-9-45	45 000	3	435	6.50
CT-9-63	63 000	4	515	7.00

### Rescue stick

Insulating stick ended by a large hook in order to rescue quickly an electrified victim in case of accident.



CS-45*	Length: 1.65 m - Rated insulation: 45 kV
CS-90*	Length: 2.05 m - Rated insulation: 90 kV
CS-225*	Length: 2.45 m - Rated insulation: 225 kV

\* Delivered with wall mounted supports.



# Personal protective equipment



## INSULATING MATS, INSULATING BOOTS

### Insulating mats

The matting is manufactured of elastomeric compounds with slip-resistant surface. High quality dielectrical rubber.

\*IEC-61111   
EN 61111



#### Individual models

Reference	Thickness (mm)	Voltage (kV)	Dimensions (m)
MP-42/11*	3	≤ 33	1 x 1
MP-42/16*	3	≤ 33	0.6 x 1
MP-42/66	3	≤ 20	0.6 x 0.6

\* IEC - 61111.

#### For placing in front of panels

Reference	Thickness (mm)	Voltage (kV)	Dimensions (m)
MP-60/03-5	3	≤ 26.5	0.6 x 5
MP-60/03-10	3	≤ 26.5	0.6 x 10
MP-100/03-5	3	≤ 26.5	1 x 5
MP-100/03-10	3	≤ 26.5	1 x 10
MP-100/04-5	4	33	1 x 5
MP-100/04-10	4	33	1 x 10
MP-60/05-5	5	≤ 36	0.6 x 5
MP-60/05-10	5	≤ 36	0.6 x 10
MP-100/05-5	5	≤ 36	1 x 5
MP-100/05-10	5	≤ 36	1 x 10
MP-100/10-5	10	> 80	1 x 5
MP-100/10-10	10	> 80	1 x 10

### Bags for insulating mats

Specially designed for carrying and protecting insulating mats. Equipped with a shoulder strap and a plastic window for instructions and storage identification.



MP-01	For MP-42/16 and MP-42/66 - Length: 70 cm
MP-02	For MP-42/11 - Length: 110 cm

### Insulating boots

Made from elastomer with canvas support, very flexible and resistant. Anti-perforation stainless steel sole and shell. Anti-slip sole. Protection against step and touch hazardous potential gradients.

EN 345  
CE



MV-135*	60 x 210 x 460 mm - Weight: 0.730 kg
---------	--------------------------------------

\* Add sizes: 39-40/41-42-43/44-45-46/47.



# Padlocks and warning signs

PADLOCKS

56

SELF ADHESIVE SIGNS

57

WARNING SIGNS

58

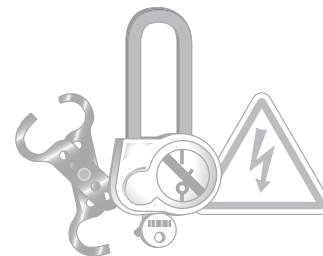

### Padlocks with warning signs

Brass ring bow 50 or 70 mm.  
Diameter of the ring bow 4 or 6 mm.



Reference	Ring bow (mm)	Ø (mm)	Weight (kg)
AL-230-111-EX	50	6	0.170
AL-230-S-222-EX	70	6	0.190
AL-240-111-EX	50	4	0.170
AL-240-S-222-EX	70	4	0.190

Differents colours available on request.

### Handle with 6 padlocks

Handle of moulded plastic for holding up to six padlocks.  
Compartment with transparent cover for key storage.



Reference	Weight (kg)	Handle with 6 padlocks
AL-236-111-EX	1.150	AL-230-111-EX
AL-236-S-111-EX	1.210	AL-230-S-111-E
AL-236-222-EX	1.150	AL-230-222-EX
AL-236-S-222-EX	1.210	AL-230-S-222-EX

### Multiple locking apparatus

Holds up to four padlocks and a sign.



AL-200



AL-202

AL-200	100 x 60 x 10 mm - Weight: 0.150 kg
AL-202	165 x 50 x 12 mm - Weight: 0.200 kg

### Single pole breaker lockout

Clipblock™, locks lever in off position to isolate and prevent breaker use.

Clipblock fits most of standard single pole devices. Quick installation with a flat blade screwdriver N°3 (MO-65203).

Lockable



AL-201/1	Delivered in Pack of 5 units
----------	------------------------------

### Single pole breaker lockout with padlock

Clipblock™, locks lever in off position to isolate and prevent breaker use.

Clipblock fits most of standard single pole devices. Quick installation with a flat blade screwdriver N°3 (MO-65203). Locked by padlock.



AL-201-C/1	Delivered with a padlock
------------	--------------------------





# Padlocks and warning signs

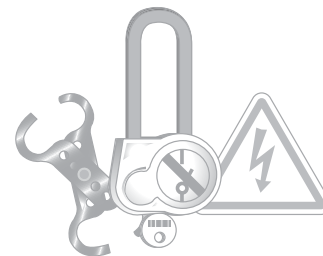

## WARNING SIGNS

### Self adhesive warning signs



Reference	Dimensions	Characteristics	Quantity/box
AT-41/025	25 mm side	Self adhesive PVC	50
AT-41/05	50 mm side	Self adhesive PVC	30
AT-41/1	100 mm side	Self adhesive PVC	20
AT-49/025	25 mm side	Self adhesive PVC	50
AT-49/05	50 mm side	Self adhesive PVC	30
AT-49/1	100 mm side	Self adhesive PVC	20
AT-50/025	25 mm side	Self adhesive PVC	50
AT-50/053	50 mm side	Self adhesive PVC	30
AT-50/1	100 mm side	Self adhesive PVC	20
AT-51/025	25 mm side	Self adhesive PVC	50
AT-51/05	50 mm side	Self adhesive PVC	30
AT-51/1	100 mm side	Self adhesive PVC	20
AT-66/1	100 mm side	Self adhesive PVC	10
AT-52/05	50 mm side	Self adhesive PVC	30
AT-52/1	100 mm side	Self adhesive PVC	20
AT-53/05	50 mm side	Self adhesive PVC	30
AT-53/1	100 mm side	Self adhesive PVC	20
AT-54/05	Ø 50 mm	Self adhesive PVC	30
AT-54/1	Ø 100 mm	Self adhesive PVC	20
AT-55/05	Ø 50 mm	Self adhesive PVC	30
AT-55/1	Ø 100 mm	Self adhesive PVC	20
AT-56/05	Ø 50 mm	Self adhesive PVC	30
AT-56/1	Ø 100 mm	Self adhesive PVC	20
AT-57/05	Ø 50 mm	Self adhesive PVC	30
AT-57/1	Ø 100 mm	Self adhesive PVC	20
AT-58/05	Ø 50 mm	Self adhesive PVC	30
AT-58/1	Ø 100 mm	Self adhesive PVC	20
AT-59/05	Ø 50 mm	Self adhesive PVC	30
AT-59/1	Ø 100 mm	Self adhesive PVC	20
AT-60/05	Ø 50 mm	Self adhesive PVC	30
AT-60/1	Ø 100 mm	Self adhesive PVC	20
AT-61/05	Ø 50 mm	Self adhesive PVC	30
AT-61/1	Ø 100 mm	Self adhesive PVC	20
AT-62/05	Ø 50 mm	Self adhesive PVC	30
AT-62/1	Ø 100 mm	Self adhesive PVC	20
AT-63/05	Ø 50 mm	Self adhesive PVC	30
AT-63/1	Ø 100 mm	Self adhesive PVC	20





# Padlocks and warning signs

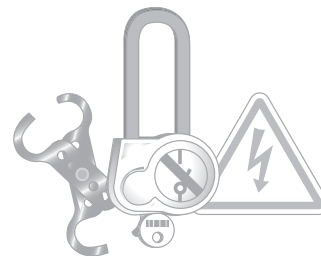

## WARNING SIGNS, DELINEATORS

### Warning and specialized signs

#### Warning signs

Reference	Type	Dimensions	Characteristics
AM-41/1*	Aluminium	100 mm side	Black on yellow Fixing: 3 holes Ø 4.5 mm
AM-49/1*	Aluminium	100 mm side	Black on yellow Fixing: 3 holes Ø 4.5 mm
AM-344-GB	Aluminium	100 mm side	Black letters on yellow Fixing: 3 holes Ø 4.5 mm
AM-345-GB	Aluminium	100 mm side	Black letters on yellow Fixing: 3 holes Ø 4.5 mm

\* Pack of 10 units.



AM-49/1



AM-41/1



AM-344-GB



AM-345-GB

#### Specialized signs

Reference	Type	Dimensions (mm)	Characteristics
AM-20-GB	Aluminium	350 x 250	Blue letters on plain aluminium
AM-20-RM	Aluminium	350 x 500	Blue letters on plain aluminium
AM-61-GB	Aluminium	150 x 200	Black on yellow on plain aluminium



AM-20-GB



AM-20-RM



AM-61-GB

### Warning flags



AL-60



AL-58

AL-58	Attached on handle; for work site
AL-60	To be attached on earthing cable; for immediate identification in open-type switchgears possible inscription: 0 to 99 (by using ALU-SCRIPT markers)

### Safety boundary post

For temporary installation. Used with tough chain link delineators (AL-32/05). Removal foot. Ø 50 mm. Length: 0.9 m.



AL-316



AL-318

AL-316	Red and White - Weight: 4.2 kg
AL-318	Black and yellow - Weight: 4.2 kg

### Chain delineators

Polyamide chains.



AL-31/25

AL-32/05

AL-31/25	Red and white - Length: 25 m
AL-32/05	Yellow and black - Length: 5 m

### Delineators

Brightly colored ribbon. Snap hook on one ribbon end and another on spool. A ring on spool brakes ribbon at desired length. Wide: 50 mm. Length: 20 m.



AL-62-A



AL-63-A

AL-62-A	Red ribbon
AL-63-A	Yellow ribbon



## General tools

EQUIPMENT FOR WORKING ON POLE

60

ACCESSORIES

64



# General tools



## EQUIPMENT FOR WORKING ON POLE

### Arc flash face shield kit (10 cal/cm<sup>2</sup>)

Composition of the kit:

1 Face shield with chin cup 10cal/cm<sup>2</sup>, absorbs > 99.9% of harmful UV radiation, 70% light transmission, tested to ASTM F2178 specifications

1 ABS helmet electrically insulated EN397, EN 50365, ANSI Z89.1, 20kV.

1 carrying bag for face shield and helmet



KIT-ARC-01

Weight: 2.1 kg

### Arc flash jacket kit (11 cal/cm<sup>2</sup>)

Composition of the kit:

1 Face shield with chin cup 10cal/cm<sup>2</sup>, absorbs > 99.9% of harmful UV radiation, tested to ASTM F2178 specifications

1 ABS helmet electrically insulated EN397, EN 50365, ANSI Z89.1, 20kV.

1 safety glasses EN 166/EN 170

1 arc flash protective jacket 11cal/cm<sup>2</sup> (size L\*), ASTM F1506 and NFPA 70E Standards

1 carrying bag for face shield and helmet

1 all kit carrying bag



KIT-ARC-02

Weight: 4.15 kg

### Arc flash protective coverall kit (11 cal/cm<sup>2</sup>)

Composition of the kit:

1 Face shield with chin cup 11cal/cm<sup>2</sup>, absorbs > 99.9% of harmful UV radiation, tested to ASTM F2178 specifications

1 ABS helmet electrically insulated EN397, EN 50365, ANSI Z89.1, 20kV.

1 safety glasses EN 166/EN 170

1 arc flash protective Hood (15 cal/cm<sup>2</sup>)

1 protective coverall 11cal/cm<sup>2</sup> (size L\*), ASTM F1506 and NFPA 70E Standards

1 carrying bag for face shield and helmet

1 all kit carrying bag



KIT-ARC-03

Weight: 4.03 kg

### Arc flash protective hood kit (40 cal/cm<sup>2</sup>)

Composition of the kit:

1 arc flash protective hood with an integrated face shield 40cal/cm<sup>2</sup>, ASTM F2178 and NFPA 70E Standards

1 arc flash protective coat 40cal/cm<sup>2</sup>, (size L\*), ASTM F1506 and NFPA 70E Standards

1 arc flash protective bib overall 40cal/cm<sup>2</sup>, (size L\*), ASTM F1506 and NFPA 70E Standards

1 ABS helmet electrically insulated EN397, EN 50365, ANSI Z89.1, 20kV.

1 safety glasses EN 166/EN 170

1 all kit carrying bag



KIT-ARC-04

Weight: 6.7 kg

\* Size US: L  
Other size on request.



# General tools

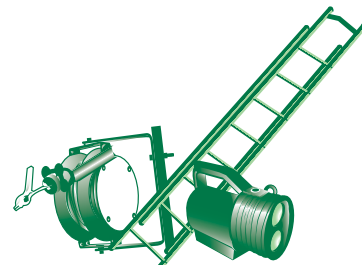

## EQUIPMENT FOR WORKING ON POLE

### Pro electric full body fall arrest harness

2 fall arrest attachment point: dorsal and sternal. Automatic buckles of the belt and leg loops. Elastic shoulder straps. Padded leg loops. A work positioning belt, with a comfortable and lightweight pad. 2 buckles of work positioning Belt. Leg loops and shoulder straps adjustable. Polyamide straps. Tools holders.

3 sizes : S, M, XL. Delivered in a protective bag with a users manual. Weight: 2.7 kg.



EN 358  
EN 361  
CE

MO-563(\*)

\* add size: S/M/XL  
S = small

M = medium

XL = large

### Pro electric full body fall arrest harness

4 fall arrest attachment point : one dorsal point, two sternal points by two metallic D rings, a sternal point by strap. A ventral attachment point for a descender and / or lanyard. Automatic buckles of leg loops. Padded leg loops. A work positioning belt, with a comfortable and lightweight pad. 2 buckles of work positioning Belt. Leg loops and shoulder straps adjustable. Polyamide straps. Tools holders

3 sizes : S, M, XL. Delivered in a protective bag with a users manual. Weight: 2.9 kg.



EN 358  
EN 361  
EN 813  
CE

MO-564(\*)

\* add size: S/M/XL  
S = small

M = medium

XL = large

### Full body fall arrest harness

2 fall arrest attachment point : dorsal and sternal. A work positioning belt, with a comfortable and lightweight pad. 2 buckles of work positioning Belt. Leg loops and shoulder straps adjustable. Polyamide straps. Unique size. Delivered in a protective bag.



EN 358  
EN 361  
CE

MO-71

Weight: 1.9 kg

### Equipped rope straps with lever stretcher

Equipped with adjuster. Hooks to belt with rapid link.



EN 358  
CE

MO-52-L

Length: 4 m - Weight: 1 kg

### Anti-fall grip

The safety block runs freely on its rope but can be automatically locked in case of a sudden downward drop. Must be used only with special 15 mm Ø rope delivered with the device.



EN 353-3  
CE

MO-68/10

With 10 m of rope - Weight: 2.300 kg

MO-68/15

With 15 m of rope - Weight: 3.250 kg

### Double safety descent device

Articulated stainless steel cam. Aluminium housing. High-resistance handle. Operates with 9-12 mm diameter lanyard. Ideal for evacuation. Lets you regulate descent.



EN 361  
CE

MD-02

Weight: 0.32 Kg

### Tether rope with energy absorber

Tether rope in polyamide Ø14 mm.



EN 355  
CE

MO-52020

Length: 1.50 m

MO-52021

Length: 2.00 m

### Double tether rope with energy absorber

Double tether rope with energy absorber Equipped with 2 steel snap hooks with automatic locking and 1 steel snap hook with screwing locking.

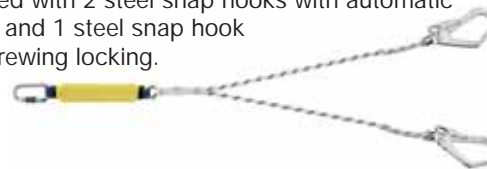

EN 355  
CE

MO-54010

Length: 1.20 m - Weight: 1.4 kg



# General tools



## EQUIPMENT FOR WORKING ON POLE

### Snap hooks (stainless steel)



MO-54

EN 362  
CE

MO-54 Locks with threaded ring - Opening: 15 mm  
105 x 58 mm - 0.154 kg



MO-55/1

EN 362  
CE

MO-55/1 Locking by screwing ring on a spring loaded mobile catch; an additional catch is provided to prevent the rope from slipping in the carabiner  
155 x 75 mm - 0.140 kg

### Snap hooks (aluminium alloy) zicral



MO-54000

EN 362

MO-54000 Oval snap hook - Opening: 15 mm  
Individually tested - Weight: 0.071 kg  
110 x 58 mm



MO-54004

EN 362  
CE

MO-54004 D-shaped snap hook with automatic locking  
Opening: 23 mm - Individually tested  
Weight: 0.087 kg - 120 x 72 mm

### Fall arrester - retractable type

Designed for lineman safety. Quick acceleration causes instant locking. Corrosion protected steel shell. Integrated braking mechanism and dissipating element. Self locking mechanism and automatic tensioning and return facility. Galvanized cable Ø 4 mm. Strength: 1 200 daN. Delivered with a screw crab. Max. length: 10 m.



EN 360

MO-591002 Weight: 7.00 kg

### Snap hook with double safety latch

Opening: 50 mm  
Body in steel  
Fingers in stainless steel  
Resistance: 20 kN.



EN 362  
CE

MO-54002 Weight: 0.390 Kg

### Tether rope equipped with a tension device

The tether rope is intended to ensure that operators are held in position when working at a height. This tether rope must be associated with a harness belt. Ends sewn to form an attachment and protected with a plastic girdle. Static resistance: 15 kN. Polyamide Ø 15 mm.



EN 358  
CE

MO-56009 Weight: 1.425 kg - Length: 3 m

MO-56010 Weight: 1.600 kg - Length: 5 m

### Safety rope with wear tell tales

Rope: 14 PEPT multi-filament (15 mm diam.)  
Two-colour safety rope, 100% polyester made of 3 white strands with black central thread (wear telltale).  
Buckle: Polyamide central lug attaches to snap-hook of belt.



EN 358  
CE

MO-052 Safety rope only - Length: 4 m - 0.76 kg

### Lanyard

Synthetic fibre ropes - 10 mm.  
Loops spliced at both ends.  
Delivered without snap hook.



EN 354  
CE

MO-53 Length: 1.50 m - Weight: 0.125 kg



# General tools



## EQUIPMENT FOR WORKING ON POLE

### Anti fall device with automatic release strap

Winder with self-locking strap.  
Length: 2 m.  
Equipped with shock absorber.  
Allows 2 m of movement autonomy  
around anchoring point.



EN 360

MO-591000

Weight: 1.160 kg

### Constraint tie

Tie in polyamide.

EN 795



CE

MO-52031 Length: 0.8 m - Weight: 0.100 kg

MO-52033 Length: 1.20 m - Weight: 0.135 kg

MO-52034 Length: 1.50 m - Weight: 0.150 kg

### Snap hook with stick adapter



MO-54005



CE-5-90-C

Reference	Characteristics
MO-54005	Opening: 50 mm - Weight: 0.500 kg
CE-5-90-C	Length: 9 m max. - Weight: 4 kg

### Working on pole kit



Reference	Use
KIT-HAUT-01-(*)	To go up a pole with insulating ladders
KIT-HAUT-02-(*)	To go up a pole with spliced ladders
KIT-HAUT-03-(*)	To go up a catenary
KIT-HAUT-04-(*)	To go up on a pylon
KIT-HAUT-05-(*)	To go up on a roof
KIT-HAUT-06-(*)	To go up using a nacelle

Composition	KIT-HAUT-					
	01-(*)	02-(*)	03-(*)	04-(*)	05-(*)	06-(*)
Harness MO-563	■	■	■			
Harness MO-564				■		
Harness MO-71					■	■
Tether rope MO-52020	■					■
Double tether rope MO-54010		■		■	■	
Constraint tie MO-52034	■	■				
Constraint tie MO-52031				■ (2)		
Tether rope with tension device MO-56009	■	■	■	■	■	
Anti-fall grip MO-68/15	■	■	■	■		
Snap hook MO-54	■	■				
Carrying bag M-87-295	■	■	■	■	■	■

(\* ) add size : M or XL

order example : KIT-HAUT-02-XL.



### Insulating ladders

A complete range with top quality features: Insulation between two steps: 30000 V (test performed after immersion in water for 24 hours). High mechanical resistance to bending and twisting. Good resistance/weight ratio. High fire resistance. High resistance against bad weather and corrosive elements. Lateral risers in polyester/glass fiber rectangular section 70 x 25 mm. Aluminium alloy rungs with square 29 x 29 mm section and anti-slip coating.

Insulating 2 section extension ladders, hand operated

Reference	Folded length (m)	Extended length (m)	Number of rungs	Weight (kg)
MP-514/2	2.41	4.09	2 x 8	13.9
MP-515/2	2.97	5.21	2 x 10	17

Insulating 2 section extension ladders, rope and pulley operated

Reference	Folded length (m)	Extended length (m)	Number of rungs	Weight (kg)
MP-506/2	3.53	6.05	2 x 12	20
MP-508/2	4.66	8.30	2 x 16	31
MP-510/2	5.78	10.26	2 x 20	38



### Forged steel climbers for round pole

Hard forged steel - Leather belts with cast buckles. Delivered by pair.



Reference	Folded length (cm)	Weight (kg)	
MO-24	Ø 20	2.6	Pair of climbers
MO-25	Ø 25	2.8	Pair of climbers
MO-26	Ø 30	3	Pair of climbers
MO-35	Ø 35	3.2	Pair of climbers

### Mechanical climbers for round and hexagonal concrete poles

Manual locking. Adaptable to the pole diameter. For poles Ø 140 to 300 mm.

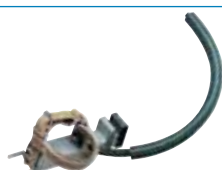

Reference	Weight (kg)	
MO-16-A	6.5	Pair of climbers

### Mechanical climbers for rectangular shaped concrete poles

Automatic locking of jaws by elastic cord. Sole in aluminium alloy, high resistance, with leather belts and steel buckle. Wear plate placed on sole arm. Mobile drum on axis can be removed; processed steel rollers. High resistance aluminium alloy rack, used for clamping onto poles 14 to 42 cm wide.



Spare parts:

- MO-17-01: pair of elastic cords
- MO-17-02: pair of wear plates
- MO-17-03: blade roller
- MO-17-04: pair of runners

Reference	Weight (kg)	
MO-17-A	9	Pair of climbers

### Climbers

For H profile metallic poles. Hard forged steel.



Reference	Weight (kg)	
MO-23	5.10	Pair of climbers





# General tools



## ACCESSORIES

### Compact carrying KIT

This compact kit is design especially to be carried in a vehicle for safety electrical intervention. Made in two part (of moulded material: PEHD), the case is also on its red part, an insulating platform.

Composition of the kit:

- 1 insulating platform
- 1 telescopic insulating stick
- 1 voltage detector with autotest
- 1 rescue hook
- 1 insulated cable cutter
- 1 pair of insulating gloves
- 1 pair of insulating boots
- 1 talk can
- 1 safety instructions and safety first aid posters
- 1 adhesive tape (black and yellow).



CZ-53-R 710 x 570 x 240 mm - Weight: 18.5 kg with instructions in English

### Connection adaptors

For insulating sticks	Accessories	E	C
For voltage detectors	Connection adaptors	CI-7-E	CI-6-C
	Sticks	K	K

### Signal for working sites

Field of use.

To remotely signal the presence of a working site by red color emission.

**Characteristics:**

Light distance: Visibility of the luminous signal at a distance of 300 m (with ambient luminancy of 200LUX).  
Discharge time: 24h at 20°C.

Rechargeable on power supply 230-50 Hz.  
IK 43/IK08.



CD-140 105 x 130 x 170 mm - Weight: 1.5 kg

### Signal for working sites

**Self-contained torch and safety lamp**, including:

- White lighting optic.
- Signalisation optical, including three colours luminous signal: red, orange and green.
- To light-up in chronological order above, push successively on run button.
- Feeding by NiCd 12 V, 1 200 m/Ah battery. Recharge by mains.
  - Lighting autonomy 5 hours.
  - Standby autonomy 10 hours.
- Load check by luminous indicator.
- Luminous signal to remember color signal.



CD-130 220 x 195 x 95 mm - Weight: 1.870 Kg



### Earthing roller

Equipotential connections.

Protection against the electrostatic loads and the shock waves consecutive to the lightnings.

- Steel strong construction stamped.
- Reel mounted on two waterproof bearings.
- Movements automatic reminder by spring with spiral blade.
- Supplied with HO7VK green yellow cable and crocodile clamp.
- Guide of the flexible hose by autolubricating pulleys.
- Directional on 180 degrees.
- Body without crankcase. Conception allowing the exchange of the flexible hose or the spring.
- Equipped normally with a pawl of stop.
- Epoxy paint.

Reference	Section and lenght				
	6 mm <sup>2</sup>	10 mm <sup>2</sup>	16 mm <sup>2</sup>	25 mm <sup>2</sup>	35 mm <sup>2</sup>
ENR-4006	40 m				
ENR-1510		15 m			
ENR-2510		25 m			
ENR-1516			15 m		
ENR-2516			25 m		
ENR-1525				15 m	
ENR-2525				25 m	
ENR-1535					15 m
ENR-2535					25 m





# General tools



## ACCESSORIES

### Camerov® VISIOCAT

Catenary inspection equipment electric traction installation.

- Colour camera
  - High resolution CCD sensor
  - Remote controlled 10 x optical zoom
  - White LEDs lights
  - Remote controlled tilt movement
  - HF transmitter
  - 4 hours autonomy
  - Weight: 600 g
  - Isolating telescopic pole reaching 11 meters
- Portable video control unit
  - hardened laptop Panasonic Toughbook
  - Touchscreen
  - HF transmitter
  - Optional GPS
  - 4 hours autonomy
  - Dim.: L x W x H = 41 x 37 x 18 cm
  - Weight: 6kg
- Soft-cat inspection reports generator software
  - Camera control (zoom, focus, tilt, lighting...)
  - 768 x 576 pixels snapshots
  - 640 x 480 pixels video clips recording
  - Inspected elements measurement with 1/10ème mm reliability reporting edition wizard
  - Multimedia CD or DVD production
  - Files and report custom design
  - Anomaly library



ZVISIOCAT

Colour camera + portable video + software

NEW RANGE OF BIMATERIAL  
INSULATED TOOLS

# ISOMIL™ 2

1000 V CEI 60900 - EN 60900

FOR LIVE WORKING UP TO 1000 VOLTS  
ACCORDING TO IEC 60900 STANDARD



Each ISOMIL tool is controlled and tested to 10 000 Volts.  
This ensured by strict quality control procedures.

**CATU™**

# Specification for short-circuiting and earthing systems



## A Network, electrical installation characteristics

Network voltage: kV \_\_\_\_\_ Max. short-circuiting current (1s): kA \_\_\_\_\_  
 Nature of the conductive materials: Basis Al  Basis Cu

### Overhead lines

- Dia. or section of the conductors: min. \_\_\_\_\_  
 max. \_\_\_\_\_

### Switchboard or substation

- Round bars dia. (mm): mini. \_\_\_\_\_ maxi. \_\_\_\_\_  
 Length = \_\_\_\_\_  
 Thickness = \_\_\_\_\_  
 - Flat bars   
   H type  Length = \_\_\_\_\_  
   V type  Thickness = \_\_\_\_\_  
 - Fitting on edge face  Fitting on side face

## B Characteristics of the earthing system

- Selected sketch (out of the three standard types shown below)
- Distance between live conductors (m): \_\_\_\_\_, between live conductors and grounding point (m) \_\_\_\_\_
- To place the clamps in position, the operator will stand: above the conductors  under the conductors   
 at the conductors level
- For cable sections, please indicate max.  $\Delta T$  or min. dia. of the conductor \_\_\_\_\_

## C Earthing connection point

- Earth rods: dia. or thickness on side face (mm): \_\_\_\_\_ Flat bar, angle-bar, thickness (mm): \_\_\_\_\_
- Round conductor dia. (mm): \_\_\_\_\_

## D Operating stick

- Insulating stick: total length \_\_\_\_\_ Fixed  Connectable stick  Telescopic

## Characteristics

- Selected connection type: Sketch n° \_\_\_\_\_
- Contact clamps (type MT- \_\_\_\_\_)
- Short-circuiting cable
  - Length (m) \_\_\_\_\_
  - Dia. or section (mm, mm<sup>2</sup>) \_\_\_\_\_
- Grounding cable
  - Length (m) \_\_\_\_\_
  - Dia. or section (mm, mm<sup>2</sup>) \_\_\_\_\_
- Connection of cables on clamps, earth clamps, trifurcation
  - Direct connection by screw and nut
  - Connection by means of crimped lugs
- Earth clamp, type \_\_\_\_\_
- Presence of a reel \_\_\_\_\_
- Insulating stick, type \_\_\_\_\_

Sketch N°1



Sketch N°2

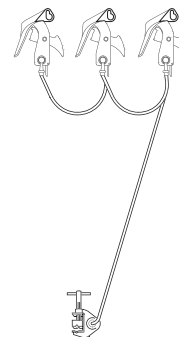

Sketch N°3

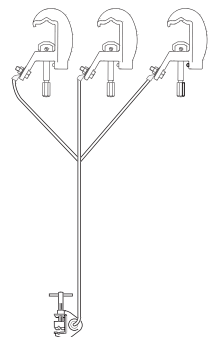

### Accessories

- Carrying bag for sticks
- Canvas bag for equipment
- Carrying case for equipment
- Cable reel



This documentation is not contractual. Items represented are proposed while stock lasts.  
CEGERS / CATU reserve the right to stop production or modify specifications without prior notice.

**Non-contractual pictures**



DISTRIBUTED BY:



<http://www.catuelec.com>

10/20 Avenue JEAN-JAURES • B.P.2 • 92222 BAGNEUX CEDEX (FRANCE)  
Phone : + 33 1 42 31 46 00 • FAX : + 33 1 42 31 46 34

*Sicame Group*